



## 2M (256K x 8) Static RAM

### Features

- **Very high speed: 55 ns and 70 ns**
- **Voltage range:**
  - CY62138CV25: 2.2V–2.7V
  - CY62138CV30: 2.7V–3.3V
  - CY62138CV33: 3.0V–3.6V
  - CY62138CV: 2.7V–3.6V
- **Pin-compatible with CY62138V**
- **Ultra low active power**
  - Typical active current: 1.5 mA @ f = 1 MHz
  - Typical active current: 5.5 mA @ f = f<sub>max</sub> (70-ns speed)
- **Low standby power**
- **Easy memory expansion with  $\overline{CE}_1$ ,  $\overline{CE}_2$ , and  $\overline{OE}$  features**
- **Automatic power-down when deselected**
- **CMOS for optimum speed/power**
- **Packages offered in a 36-ball FBGA**

### Functional Description<sup>[1]</sup>

The CY62138CV25/30/33 and CY62138CV are high-performance CMOS static RAMs organized as 256K words by eight

bits. This device features advanced circuit design to provide ultra-low active current. This is ideal for providing More Battery Life™ (MoBL<sup>®</sup>) in portable applications. The device also has an automatic power-down feature that significantly reduces power consumption by 80% when addresses are not toggling. The device can be put into standby mode reducing power consumption by more than 99% when deselected ( $\overline{CE}_1$  HIGH or  $\overline{CE}_2$  LOW).

Writing to the device is accomplished by taking Chip Enable 1 ( $\overline{CE}_1$ ) and Write Enable ( $\overline{WE}$ ) inputs LOW and Chip Enable 2 ( $\overline{CE}_2$ ) HIGH. Data on the eight I/O pins (I/O<sub>0</sub> through I/O<sub>7</sub>) is then written into the location specified on the address pins (A<sub>0</sub> through A<sub>17</sub>).

Reading from the device is accomplished by taking Chip Enable 1 ( $\overline{CE}_1$ ) and Output Enable ( $\overline{OE}$ ) LOW while forcing Write Enable ( $\overline{WE}$ ) and Chip Enable 2 ( $\overline{CE}_2$ ) HIGH. Under these conditions, the contents of the memory location specified by the address pins will appear on the I/O pins.

The eight input/output pins (I/O<sub>0</sub> through I/O<sub>7</sub>) are placed in a high-impedance state when the device is deselected ( $\overline{CE}_1$  HIGH or  $\overline{CE}_2$  LOW), the outputs are disabled ( $\overline{OE}$  HIGH), or during a write operation ( $\overline{CE}_1$  LOW,  $\overline{CE}_2$  HIGH and  $\overline{WE}$  LOW). See the truth table at the back of this data sheet for a complete description of read and write modes.

### Logic Block Diagram

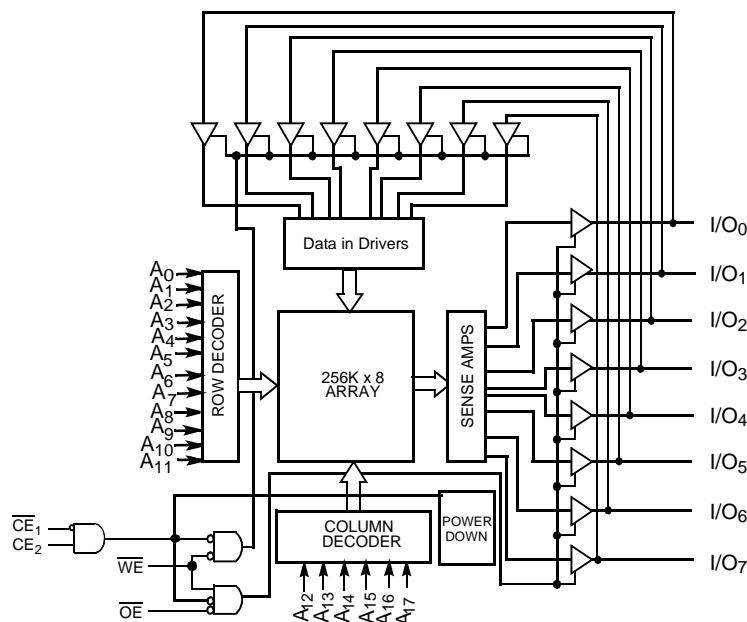

#### Note:

1. For best practice recommendations, please refer to the Cypress application note "System Design Guidelines" on <http://www.cypress.com>.

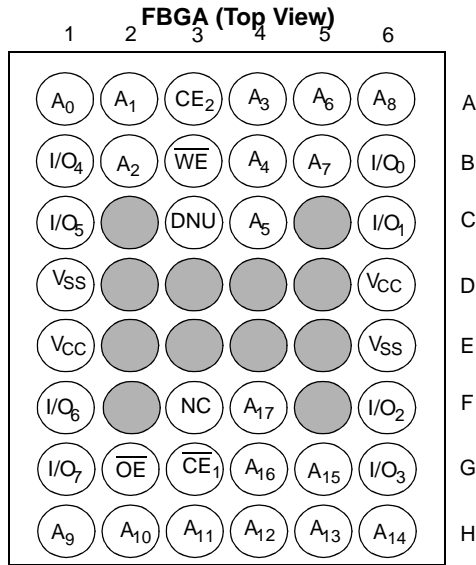
**Pin Configuration** <sup>[2, 3]</sup>

**Maximum Ratings**

(Above which the useful life may be impaired. For user guidelines, not tested.)

Storage Temperature ..... -65°C to +150°C

Ambient Temperature with Power Applied ..... 55°C to +125°C

Supply Voltage to Ground Potential ... -0.5V V<sub>CCMAX</sub> + 0.5V

DC Voltage Applied to Outputs in High-Z State<sup>[4]</sup> ..... 0.5V to V<sub>CC</sub> + 0.3V

DC Input Voltage<sup>[4]</sup> ..... -0.5V to V<sub>CC</sub> + 0.3V

Output Current into Outputs (LOW) ..... 20 mA

Static Discharge Voltage..... > 2001V (per MIL-STD-883, Method 3015)

Latch-Up Current ..... > 200 mA

**Operating Range**

Product	Range	Ambient Temperature T <sub>A</sub>	V <sub>CC</sub>
CY62138CV25	Industrial	-40°C to +85°C	2.2V to 2.7V
CY62138CV30			2.7V to 3.3V
CY62138CV33			3.0V to 3.6V
CY62138CV			2.7V to 3.6V

**Product Portfolio**

Product	V <sub>CC</sub> Range (V)			Speed (ns)	Power Dissipation					
					Operating, I <sub>CC</sub> (mA)				Standby, I <sub>SB2</sub> (μA)	
	Min.	Typ. <sup>[5]</sup>	Max.		f = 1 MHz		f = f <sub>max</sub>		Typ. <sup>[5]</sup>	Max.
					Typ. <sup>[5]</sup>	Max.	Typ. <sup>[5]</sup>	Max.		
CY62138CV25LL	2.2	2.5	2.7	55	1.5	3	7	15	2	10
				70	1.5	3	5.5	12		
CY62138CV30LL	2.7	3.0	3.3	55	1.5	3	7	15	2	10
				70	1.5	3	5.5	12		
CY62138CV33LL	3.0	3.3	3.6	55	1.5	3	7	15	5	15
				70	1.5	3	5.5	12		
CY62138CVLL	2.7	3.3	3.6	70	1.5	3	5.5	12	5	15

**Notes:**

2. NC pins are not connected to the die.
3. C3 (DNU) can be left as NC or V<sub>SS</sub> to ensure proper application.
4. V<sub>L(min.)</sub> = -2.0V for pulse durations less than 20 ns.
5. Typical values are included for reference only and are not guaranteed or tested. Typical values are measured at V<sub>CC</sub> = V<sub>CC(typ.)</sub>, T<sub>A</sub> = 25°C.

**Electrical Characteristics** Over the Operating Range

Parameter	Description	Test Conditions		CY62138CV25-55			CY62138CV25-70			Unit
				Min.	Typ. <sup>[5]</sup>	Max.	Min.	Typ. <sup>[5]</sup>	Max.	
V <sub>OH</sub>	Output HIGH Voltage	I <sub>OH</sub> = -0.1 mA	V <sub>CC</sub> = 2.2V	2.0			2.0			V
V <sub>OL</sub>	Output LOW Voltage	I <sub>OL</sub> = 0.1 mA	V <sub>CC</sub> = 2.2V			0.4			0.4	V
V <sub>IH</sub>	Input HIGH Voltage			1.8		V <sub>CC</sub> + 0.3V	1.8		V <sub>CC</sub> + 0.3V	V
V <sub>IL</sub>	Input LOW Voltage			-0.3		0.6	-0.3		0.6	V
I <sub>Ix</sub>	Input Leakage Current	GND ≤ V <sub>I</sub> ≤ V <sub>CC</sub>		-1		+1	-1		+1	μA
I <sub>OZ</sub>	Output Leakage Current	GND ≤ V <sub>O</sub> ≤ V <sub>CC</sub> , Output Disabled		-1		+1	-1		+1	μA
I <sub>CC</sub>	V <sub>CC</sub> Operating Supply Current	f = f <sub>MAX</sub> = 1/t <sub>RC</sub>	V <sub>CC</sub> = 2.7V I <sub>OUT</sub> = 0 mA CMOS Levels		7	15		5.5	12	mA
		f = 1 MHz			1.5	3		1.5	3	
I <sub>SB1</sub>	Automatic CE Power-down Current — CMOS Inputs	CE <sub>1</sub> ≥ V <sub>CC</sub> - 0.2V or CE <sub>2</sub> ≤ 0.2V V <sub>IN</sub> ≥ V <sub>CC</sub> - 0.2V or V <sub>IN</sub> ≤ 0.2V, f = f <sub>max</sub> (Address and Data Only), f = 0 (OE, WE)			2	10		2	10	μA
I <sub>SB2</sub>	Automatic CE Power-down Current — CMOS Inputs	CE <sub>1</sub> ≥ V <sub>CC</sub> - 0.2V or CE <sub>2</sub> ≤ 0.2V V <sub>IN</sub> ≥ V <sub>CC</sub> - 0.2V or V <sub>IN</sub> ≤ 0.2V, f = 0, V <sub>CC</sub> = 2.7V								

Parameter	Description	Test Conditions		CY62138CV30-55			CY62138CV30-70			Unit
				Min.	Typ. <sup>[5]</sup>	Max.	Min.	Typ. <sup>[5]</sup>	Max.	
V <sub>OH</sub>	Output HIGH Voltage	I <sub>OH</sub> = -1.0 mA	V <sub>CC</sub> = 2.7V	2.4			2.4			V
V <sub>OL</sub>	Output LOW Voltage	I <sub>OL</sub> = 2.1 mA	V <sub>CC</sub> = 2.7V			0.4			0.4	V
V <sub>IH</sub>	Input HIGH Voltage			2.2		V <sub>CC</sub> + 0.3V	2.2		V <sub>CC</sub> + 0.3V	V
V <sub>IL</sub>	Input LOW Voltage			-0.3		0.8	-0.3		0.8	V
I <sub>Ix</sub>	Input Leakage Current	GND ≤ V <sub>I</sub> ≤ V <sub>CC</sub>		-1		+1	-1		+1	μA
I <sub>OZ</sub>	Output Leakage Current	GND ≤ V <sub>O</sub> ≤ V <sub>CC</sub> , Output Disabled		-1		+1	-1		+1	μA
I <sub>CC</sub>	V <sub>CC</sub> Operating Supply Current	f = f <sub>MAX</sub> = 1/t <sub>RC</sub>	V <sub>CC</sub> = 3.3V I <sub>OUT</sub> = 0 mA CMOS Levels		7	15		5.5	12	mA
		f = 1 MHz			1.5	3		1.5	3	
I <sub>SB1</sub>	Automatic CE Power-down Current — CMOS Inputs	CE <sub>1</sub> ≥ V <sub>CC</sub> - 0.2V or CE <sub>2</sub> ≤ 0.2V V <sub>IN</sub> ≥ V <sub>CC</sub> - 0.2V or V <sub>IN</sub> ≤ 0.2V, f = f <sub>max</sub> (Address and Data Only), f = 0 (OE, WE)			2	10		2	10	μA
I <sub>SB2</sub>	Automatic CE Power-down Current — CMOS Inputs	CE <sub>1</sub> ≥ V <sub>CC</sub> - 0.2V or CE <sub>2</sub> ≤ 0.2V, V <sub>IN</sub> ≥ V <sub>CC</sub> - 0.2V or V <sub>IN</sub> ≤ 0.2V, f = 0, V <sub>CC</sub> = 3.3V								

**Electrical Characteristics** Over the Operating Range

Parameter	Description	Test Conditions	CY62138CV33-55			CY62138CV33-70 CY62138CV-70			Unit
			Min.	Typ. <sup>[5]</sup>	Max.	Min.	Typ. <sup>[5]</sup>	Max.	
V <sub>OH</sub>	Output HIGH Voltage	I <sub>OH</sub> = -1.0 mA	V <sub>CC</sub> = 3.0V	2.4			2.4		V
			V <sub>CC</sub> = 2.7V				2.4		V
V <sub>OL</sub>	Output LOW Voltage	I <sub>OL</sub> = 2.1 mA	V <sub>CC</sub> = 3.0V			0.4			V
			V <sub>CC</sub> = 2.7V					0.4	V
V <sub>IH</sub>	Input HIGH Voltage		2.2		V <sub>CC</sub> + 0.3V	2.2		V <sub>CC</sub> + 0.3V	V
V <sub>IL</sub>	Input LOW Voltage		-0.3		0.8	-0.3		0.8	V
I <sub>Ix</sub>	Input Leakage Current	GND ≤ V <sub>I</sub> ≤ V <sub>CC</sub>	-1		+1	-1		+1	μA
I <sub>OZ</sub>	Output Leakage Current	GND ≤ V <sub>O</sub> ≤ V <sub>CC</sub> , Output Disabled	-1		+1	-1		+1	μA
I <sub>CC</sub>	V <sub>CC</sub> Operating Supply Current	f = f <sub>MAX</sub> = 1/t <sub>RC</sub>	V <sub>CC</sub> = 3.6V I <sub>OUT</sub> = 0 mA CMOS Levels	7	15	5.5	12	mA	
		f = 1 MHz		1.5	3				1.5
I <sub>SB1</sub>	Automatic CE Power-down Current—CMOS Inputs	CE <sub>1</sub> ≥ V <sub>CC</sub> - 0.2V or CE <sub>2</sub> ≤ 0.2V V <sub>IN</sub> ≥ V <sub>CC</sub> - 0.2V or V <sub>IN</sub> ≤ 0.2V, f = f <sub>max</sub> (Address and Data Only), f = 0 (OE,WE)		5	15		5	15	μA
I <sub>SB2</sub>	Automatic CE Power-down Current—CMOS Inputs	CE <sub>1</sub> ≥ V <sub>CC</sub> - 0.2V or CE <sub>2</sub> ≤ 0.2V V <sub>IN</sub> ≥ V <sub>CC</sub> - 0.2V or V <sub>IN</sub> ≤ 0.2V, f = 0, V <sub>CC</sub> = 3.6V							

**Capacitance<sup>[6]</sup>**

Parameter	Description	Test Conditions	Max.	Unit
C <sub>IN</sub>	Input Capacitance	T <sub>A</sub> = 25°C, f = 1 MHz, V <sub>CC</sub> = V <sub>CC(typ.)</sub>	6	pF
C <sub>OUT</sub>	Output Capacitance		8	pF

**Thermal Resistance**

Parameter	Description	Test Conditions	BGA	Unit
Θ <sub>JA</sub>	Thermal Resistance <sup>[6]</sup> (Junction to Ambient)	Still Air, soldered on a 3 x 4.5 inch, two-layer printed circuit board	55	°C/W
Θ <sub>JC</sub>	Thermal Resistance <sup>[6]</sup> (Junction to Case)		16	°C/W

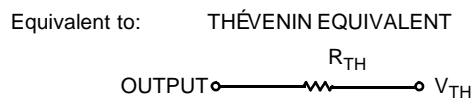
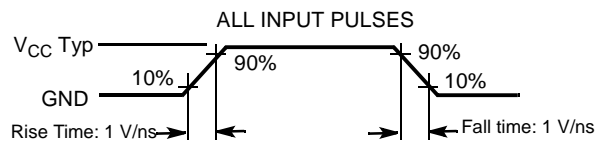
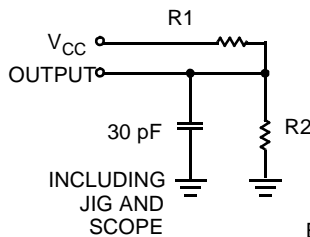
**AC Test Loads and Waveforms**

**Note:**

6. Tested initially and after any design or process changes that may affect these parameters.

Parameters	2.5V	3.0V	3.3V	Unit
R1	16600	1105	1216	$\Omega$
R2	15400	1550	1374	$\Omega$
R <sub>TH</sub>	8000	645	645	$\Omega$
V <sub>TH</sub>	1.20	1.75	1.75	V

**Data Retention Characteristics** (Over the Operating Range)

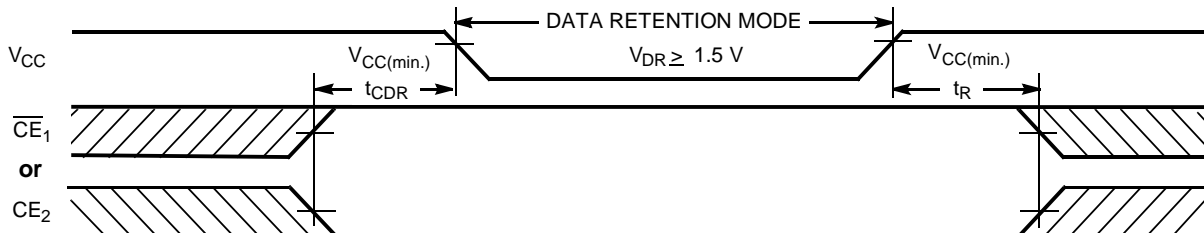
Parameter	Description	Conditions	Min.	Typ. <sup>[5]</sup>	Max.	Unit
V <sub>DR</sub>	V <sub>CC</sub> for Data Retention		1.5		V <sub>CC(max.)</sub>	V
I <sub>CCDR</sub>	Data Retention Current	V <sub>CC</sub> = 1.5V CE <sub>1</sub> ≥ V <sub>CC</sub> - 0.2V or CE <sub>2</sub> ≤ 0.2V V <sub>IN</sub> ≥ V <sub>CC</sub> - 0.2V or V <sub>IN</sub> ≤ 0.2V		1	6	$\mu$ A
t <sub>CDR</sub> <sup>[6]</sup>	Chip Deselect to Data Retention Time		0			ns
t <sub>R</sub> <sup>[7]</sup>	Operation Recovery Time		t <sub>RC</sub>			ns

**Data Retention Waveform**

**Switching Characteristics** Over the Operating Range<sup>[8]</sup>

Parameter	Description	55 ns		70 ns		Unit
		Min.	Max.	Min.	Max.	
<b>Read Cycle</b>						
t <sub>RC</sub>	Read Cycle Time	55		70		ns
t <sub>AA</sub>	Address to Data Valid		55		70	ns
t <sub>OHA</sub>	Data Hold from Address Change	10		10		ns
t <sub>ACE</sub>	CE <sub>1</sub> LOW and CE <sub>2</sub> HIGH to Data Valid		55		70	ns
t <sub>DOE</sub>	OE LOW to Data Valid		25		35	ns
t <sub>LZOE</sub>	OE LOW to Low-Z <sup>[9]</sup>	5		5		ns
t <sub>HZOE</sub>	OE HIGH to High-Z <sup>[9, 10]</sup>		20		25	ns
t <sub>LZCE</sub>	CE <sub>1</sub> LOW and CE <sub>2</sub> HIGH to Low-Z <sup>[9]</sup>	10		10		ns
t <sub>HZCE</sub>	CE <sub>1</sub> HIGH or CE <sub>2</sub> LOW to High-Z <sup>[9, 10]</sup>		20		25	ns
t <sub>PU</sub>	CE <sub>1</sub> LOW and CE <sub>2</sub> HIGH to Power-up	0		0		ns
t <sub>PD</sub>	CE <sub>1</sub> HIGH or CE <sub>2</sub> LOW to Power-down		55		70	ns
<b>Write Cycle<sup>[11]</sup></b>						
t <sub>WC</sub>	Write Cycle Time	55		70		ns
t <sub>SCE</sub>	CE <sub>1</sub> LOW and CE <sub>2</sub> HIGH to Write End	45		60		ns

**Notes:**

- Full-device AC operation requires linear V<sub>CC</sub> ramp from V<sub>DR</sub> to V<sub>CC(min.)</sub> ≥ 100  $\mu$ s or stable at V<sub>CC(min.)</sub> ≥ 100  $\mu$ s.
- Test conditions assume signal transition time of 5 ns or less, timing reference levels of V<sub>CC(typ.)</sub>/2, input pulse levels of 0 to V<sub>CC(typ.)</sub>, and output loading of the specified I<sub>OL</sub>/I<sub>OH</sub> and 30-pF load capacitance.
- At any given temperature and voltage condition, t<sub>HZCE</sub> is less than t<sub>LZCE</sub>, t<sub>HZOE</sub> is less than t<sub>LZOE</sub>, and t<sub>HZWE</sub> is less than t<sub>LZWE</sub> for any given device.
- t<sub>HZOE</sub>, t<sub>HZCE</sub>, and t<sub>HZWE</sub> transitions are measured when the outputs enter a high-impedance state.
- The internal write time of the memory is defined by the overlap of WE, CE<sub>1</sub> = V<sub>IL</sub>, and CE<sub>2</sub> = V<sub>IH</sub>. All signals must be ACTIVE to initiate a write and any of these signals can terminate a write by going INACTIVE. The data input set-up and hold timing should be referenced to the edge of the signal that terminates the write.

**Switching Characteristics** Over the Operating Range<sup>[8]</sup> (continued)

Parameter	Description	55 ns		70 ns		Unit
		Min.	Max.	Min.	Max.	
$t_{AW}$	Address Set-up to Write End	45		60		ns
$t_{HA}$	Address Hold from Write End	0		0		ns
$t_{SA}$	Address Set-up to Write Start	0		0		ns
$t_{PWE}$	$\overline{WE}$ Pulse Width	40		45		ns
$t_{SD}$	Data Set-up to Write End	25		30		ns
$t_{HD}$	Data Hold from Write End	0		0		ns
$t_{HZWE}$	$\overline{WE}$ LOW to High-Z <sup>[9, 10]</sup>		20		25	ns
$t_{LZWE}$	$\overline{WE}$ HIGH to Low-Z <sup>[9]</sup>	10		10		ns

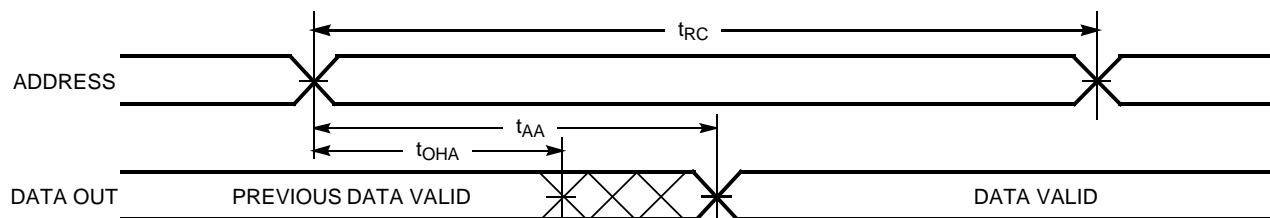
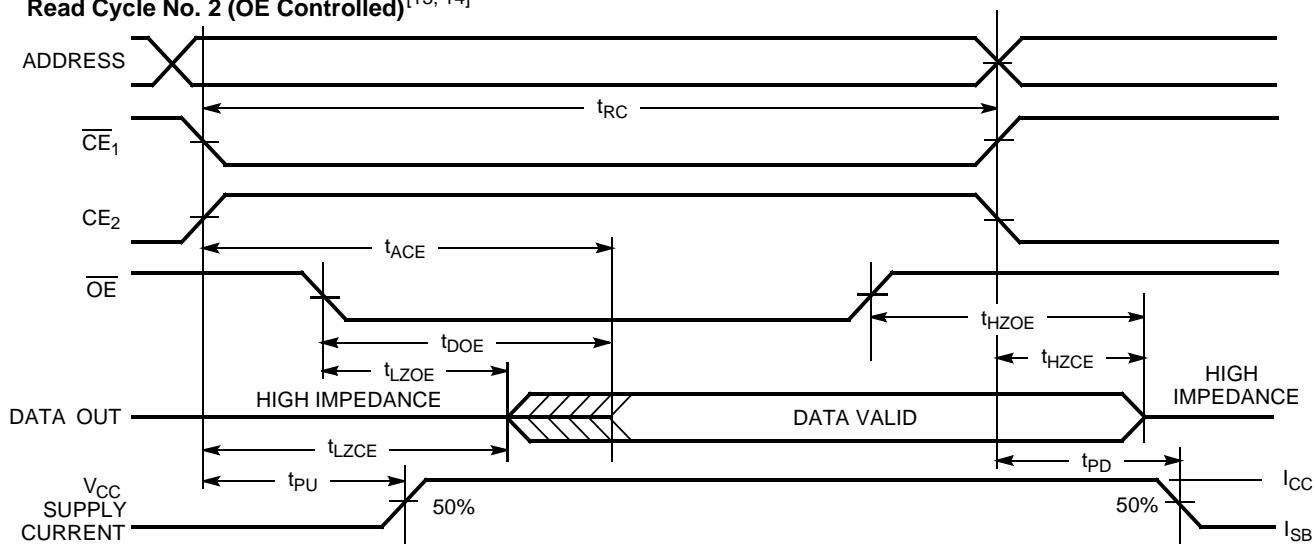
**Switching Waveforms**
**Read Cycle No. 1 (Address Transition Controlled)** <sup>[12, 13]</sup>

**Read Cycle No. 2 ( $\overline{OE}$  Controlled)** <sup>[13, 14]</sup>

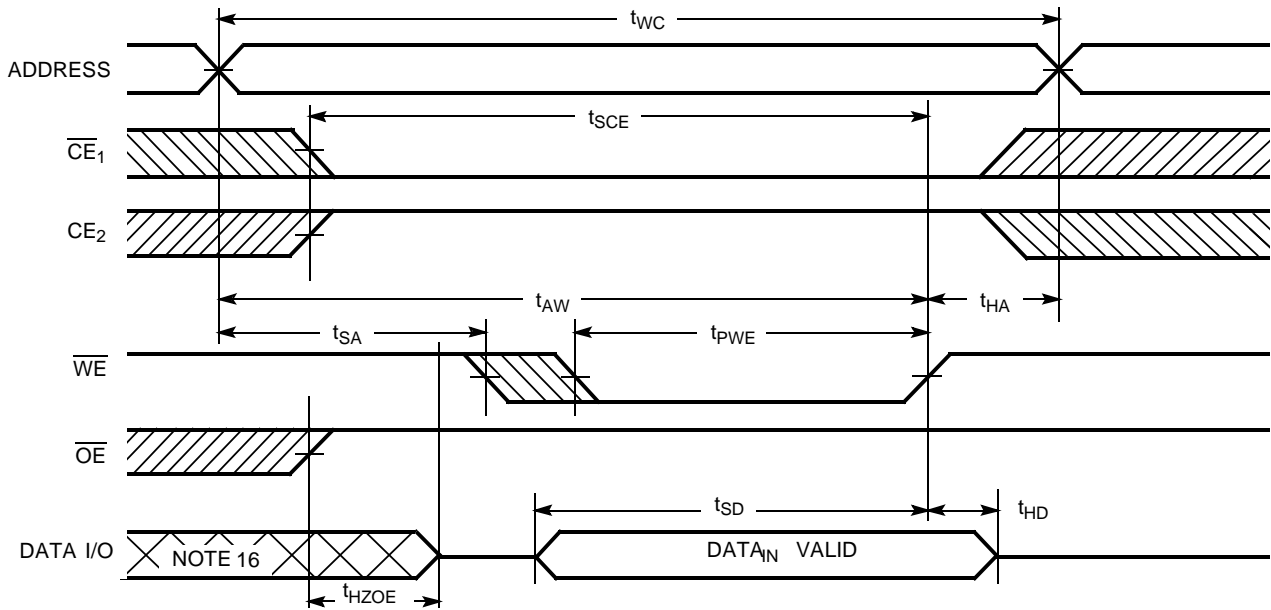
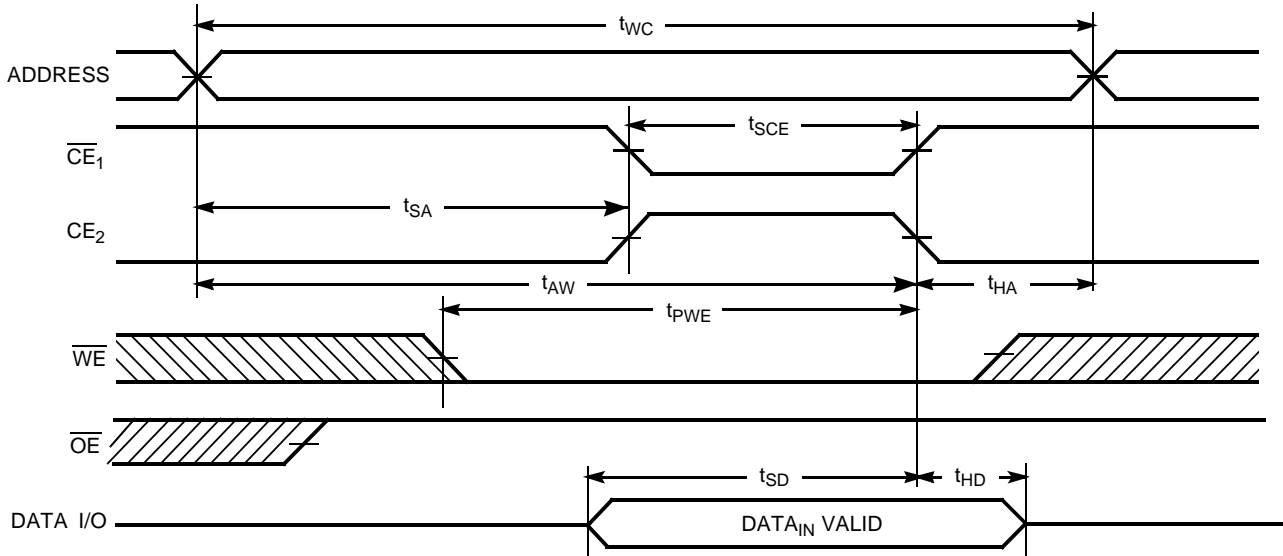
**Notes:**

12. Device is continuously selected.  $\overline{OE}$ ,  $\overline{CE}_1 = V_{IL}$ ,  $CE_2 = V_{IH}$ .
13.  $\overline{WE}$  is HIGH for read cycle.
14. Address valid prior to or coincident with  $\overline{CE}_1$  transition LOW and  $CE_2$  transition HIGH.

**Switching Waveforms (continued)**
**Write Cycle No. 1 ( $\overline{WE}$  Controlled)<sup>[11, 15, 17]</sup>**

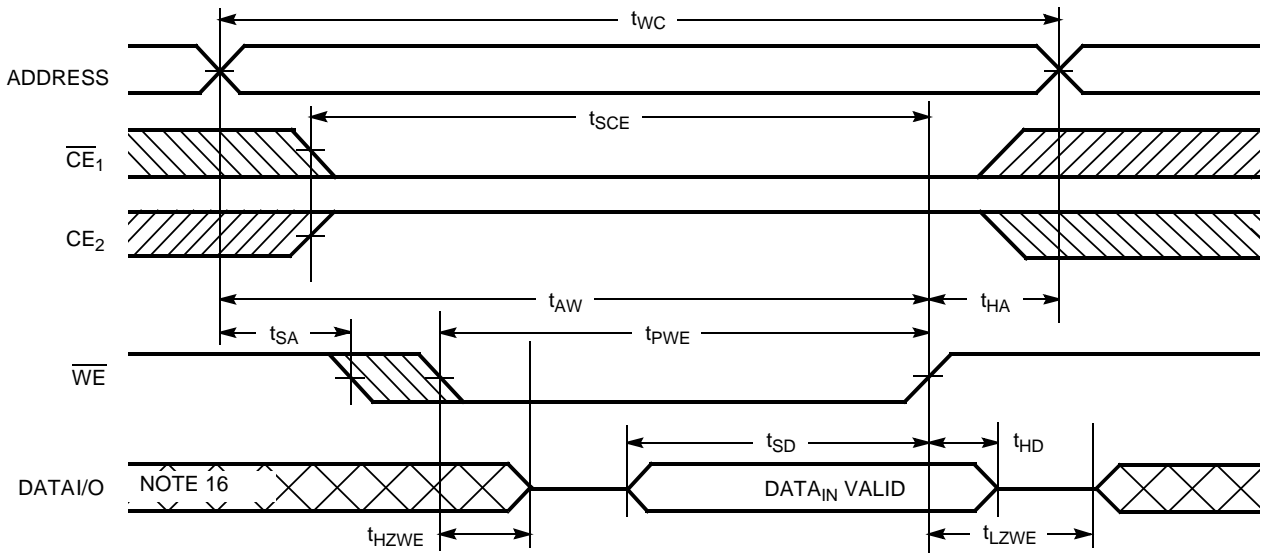
**Write Cycle No. 2 ( $\overline{CE}_1$  or  $CE_2$  Controlled)<sup>[11, 15, 17]</sup>**

**Notes:**

15. Data I/O is high impedance if  $\overline{OE} = V_{IH}$ .
16. During this period, the I/Os are in output state and input signals should not be applied.
17. If  $\overline{CE}_1$  goes HIGH or  $CE_2$  goes LOW simultaneously with  $\overline{WE}$  HIGH, the output remains in high-impedance state.

**Switching Waveforms** (continued)

**Write Cycle No. 3 ( $\overline{WE}$  Controlled,  $\overline{OE}$  LOW)<sup>[17]</sup>**



## Typical DC and AC Parameters

(Typical values are included for reference only and are not guaranteed or tested. Typical values are measured at  $V_{CC} = V_{CC(typ.)}$ ,  $T_A = 25^\circ C$ )

### Operating Current vs. Supply Voltage

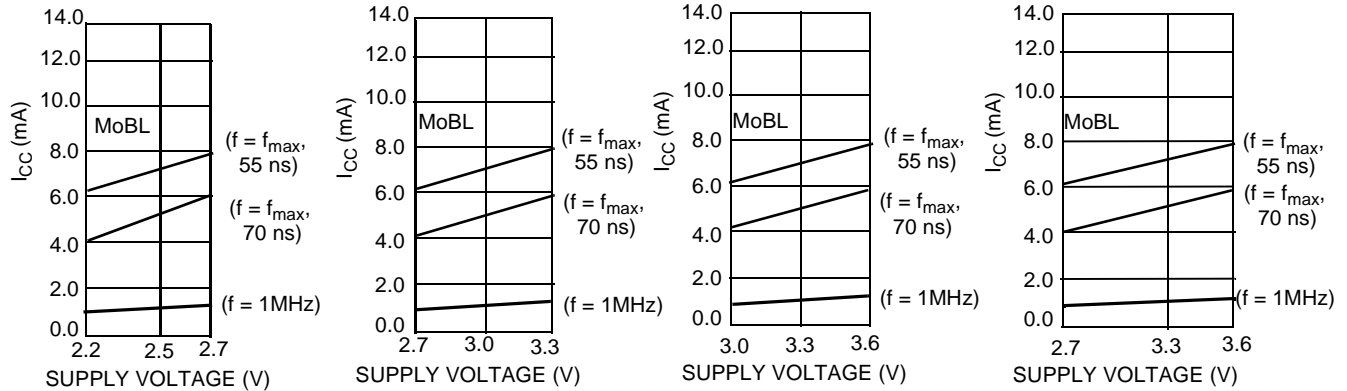

### Standby Current vs. Supply Voltage

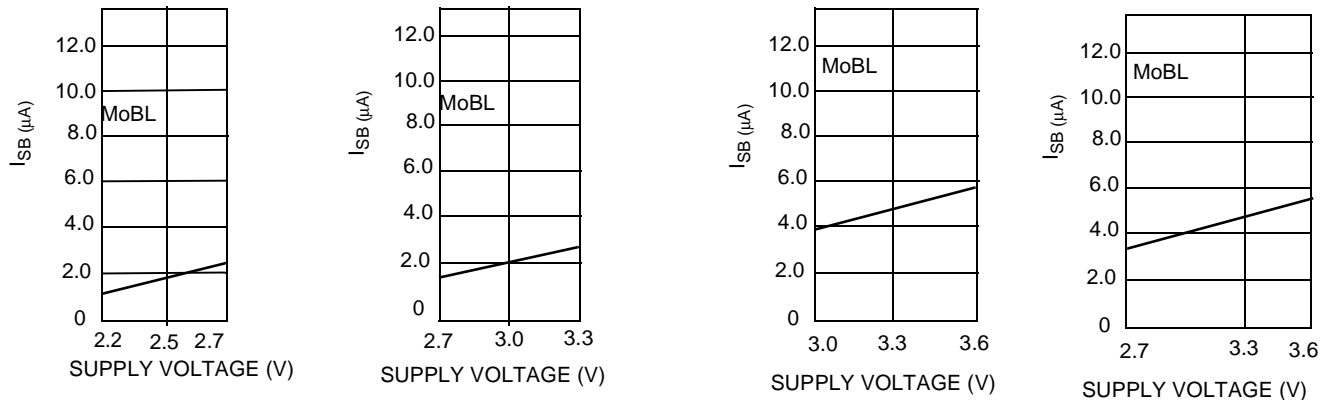

### Access Time vs. Supply Voltage

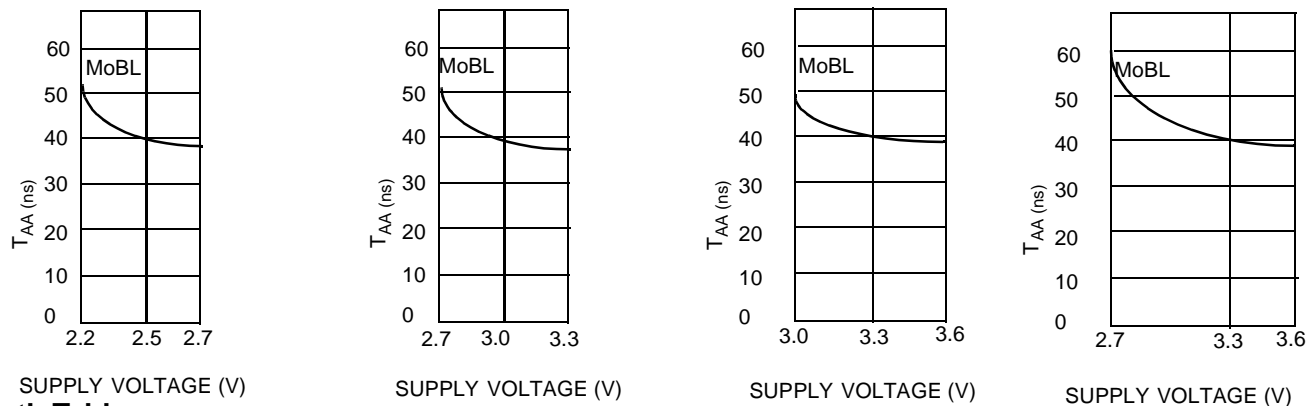

### Truth Table

$\overline{CE}_1$	$\overline{CE}_2$	$\overline{WE}$	$\overline{OE}$	Inputs/Outputs	Mode	Power
H	X	X	X	High-Z	Deselect/Power-down	Standby ( $I_{SB}$ )
X	L	X	X	High-Z	Deselect/Power-down	Standby ( $I_{SB}$ )
L	H	H	L	Data Out ( $I/O_0$ - $I/O_7$ )	Read	Active ( $I_{CC}$ )
L	H	H	H	High-Z	Output Disabled	Active ( $I_{CC}$ )
L	H	L	X	Data in ( $I/O_0$ - $I/O_7$ )	Write	Active ( $I_{CC}$ )

**Ordering Information**

Speed (ns)	Ordering Code	Voltage Range (V)	Package Name	Package Type	Operating Range
70	CY62138CV25LL-70BAI	2.2–2.7	BA36A	36-ball Fine Pitch BGA (7 mm x 7 mm x 1.2 mm)	Industrial
	CY62138CV25LL-70BVI	2.2–2.7	BV36A	36-ball Fine Pitch BGA (6 mm x 8 mm x 1 mm)	
	CY62138CV30LL-70BAI	2.7–3.3	BA36A	36-ball Fine Pitch BGA (7 mm x 7 mm x 1.2 mm)	
	CY62138CV30LL-70BVI	2.7–3.3	BV36A	36-ball Fine Pitch BGA (6 mm x 8 mm x 1 mm)	
	CY62138CV33LL-70BAI	3.0–3.6	BA36A	36-ball Fine Pitch BGA (7 mm x 7 mm x 1.2 mm)	
	CY62138CV33LL-70BVI	3.0–3.6	BV36A	36-ball Fine Pitch BGA (6 mm x 8 mm x 1 mm)	
	CY62138CVLL-70BAI	2.7–3.6	BA36A	36-ball Fine Pitch BGA (7 mm x 7 mm x 1.2 mm)	
	CY62138CVLL-70BVI	2.7–3.6	BV36A	36-ball Fine Pitch BGA (6 mm x 8 mm x 1 mm)	
55	CY62138CV25LL-55BAI	2.2–2.7	BA36A	36-ball Fine Pitch BGA (7 mm x 7 mm x 1.2 mm)	Industrial
	CY62138CV25LL-55BVI	2.2–2.7	BV36A	36-ball Fine Pitch BGA (6 mm x 8 mm x 1 mm)	
	CY62138CV30LL-55BAI	2.7–3.3	BA36A	36-ball Fine Pitch BGA (7 mm x 7 mm x 1.2 mm)	
	CY62138CV30LL-55BVI	2.7–3.3	BV36A	36-ball Fine Pitch BGA (6 mm x 8 mm x 1 mm)	
	CY62138CV33LL-55BAI	3.0–3.6	BA36A	36-ball Fine Pitch BGA (7 mm x 7 mm x 1.2 mm)	
	CY62138CV33LL-55BVI	3.0–3.6	BV36A	36-ball Fine Pitch BGA (6 mm x 8 mm x 1 mm)	

**Package Diagrams**

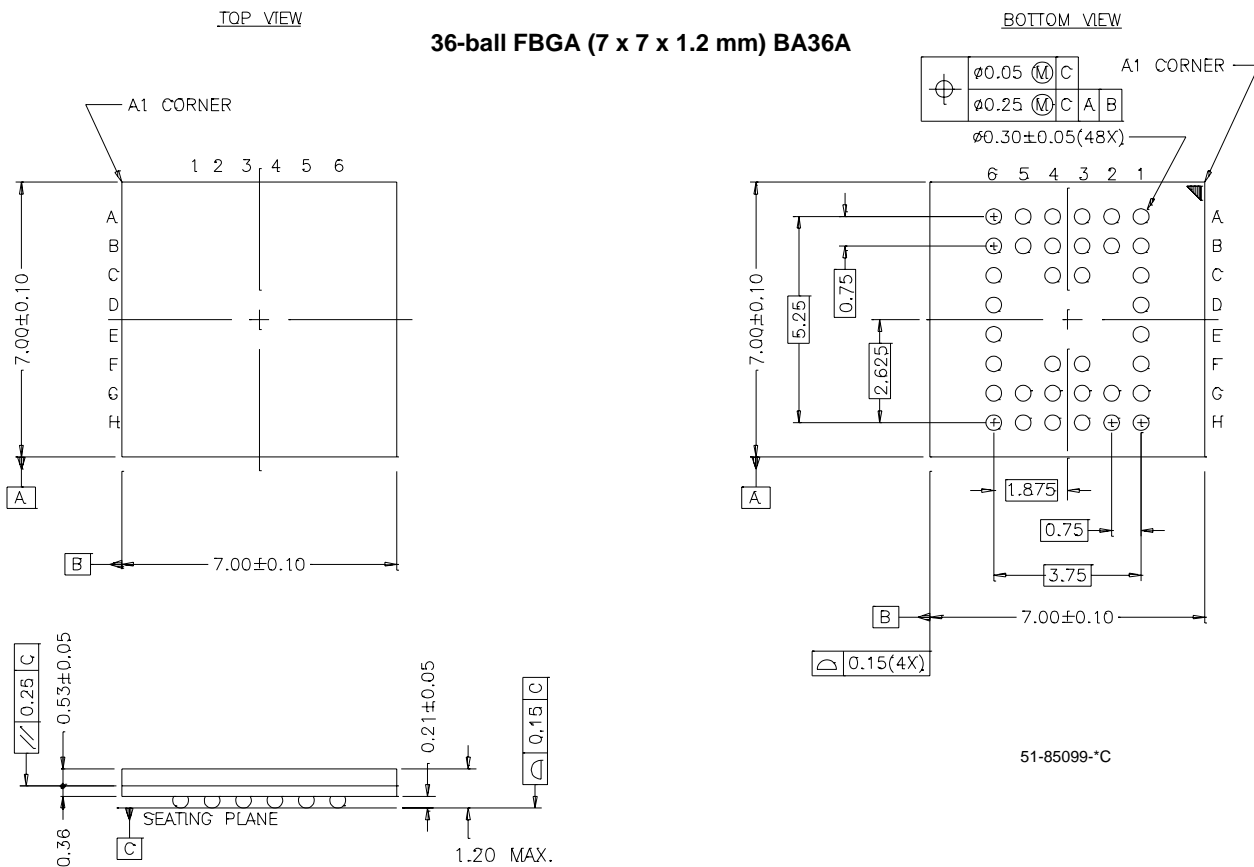

**Package Diagrams** (continued)

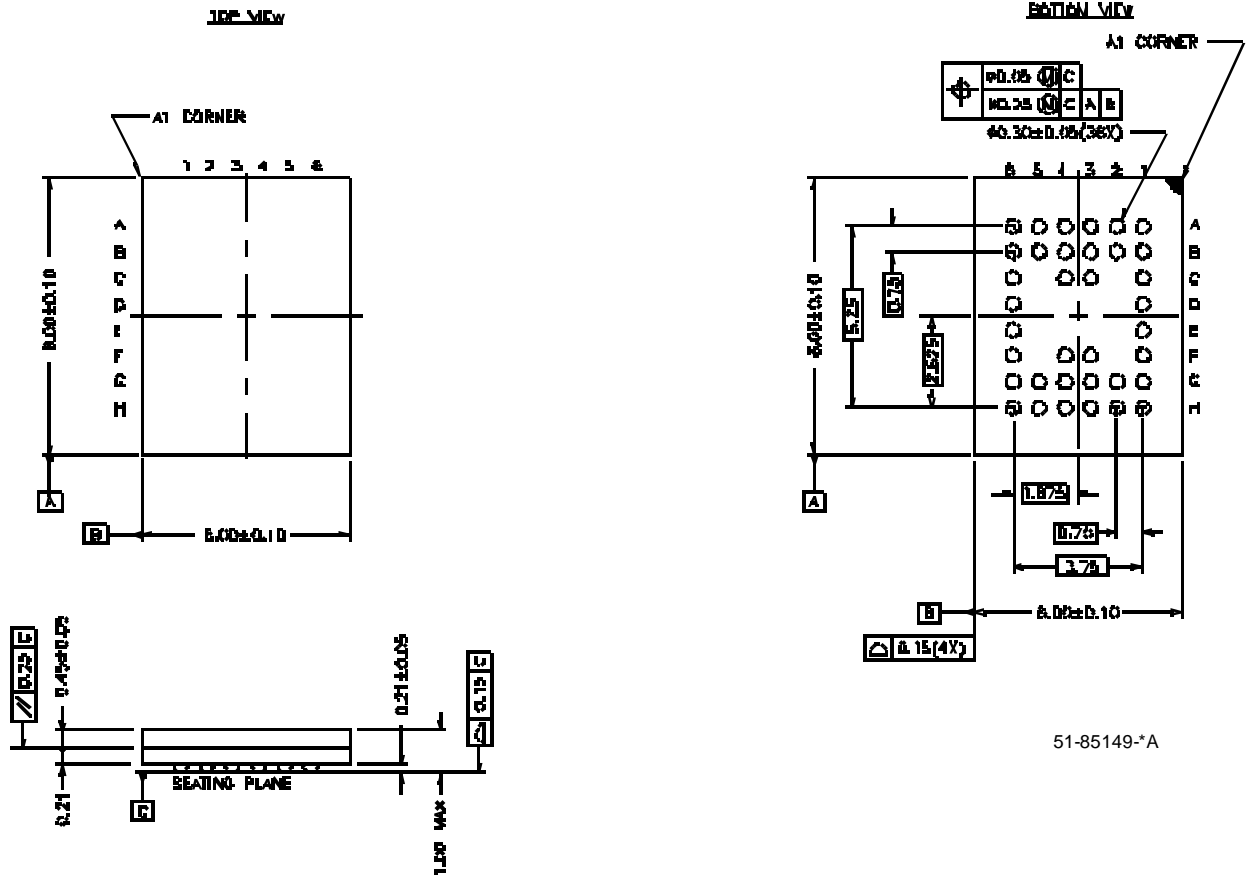
**36-Lead VFBGA (6 x 8 x 1 mm) BV36A**

MoBL is a registered trademark and More Battery Life is a trademark of Cypress Semiconductor Corporation. All product and company names mentioned in this document may be the trademarks of their respective holders.



**Document History Page**

Document Title: CY62138CV25/30/33 MoBL <sup>®</sup> /CY62138CV MoBL <sup>®</sup> 2M (256K x 8) Static RAM				
Document Number: 38-05200				
REV.	ECN NO.	Issue Date	Orig. of Change	Description of Change
**	112381	02/19/02	GAV	New Data Sheet (advance information)
*A	114024	04/25/02	JUI	Added BV package diagram Changed from Advance Information to Preliminary
*B	117062	07/12/02	MGN	Added Second Chip Enable Changed from Preliminary to Final
*C	118123	09/09/02	MGN	Added new part number: CY62138CV with wider voltage (2.7V – 3.6V) For T <sub>AA</sub> = 55 ns, improved t <sub>PWE</sub> min. from 45 ns to 40 ns For T <sub>AA</sub> = 70 ns, improved t <sub>PWE</sub> min. from 60 ns to 45 ns For T <sub>AA</sub> = 70 ns, improved t <sub>LZWE</sub> min. from 5 ns to 10 ns
*D	118760	09/23/02	MGN	Improved Typ. I <sub>CC</sub> spec. to 7 mA (for 55 ns) and 5.5 mA (for 70 ns). Improved Max I <sub>CC</sub> spec. to 15 mA (for 55 ns) and 12 mA (for 70 ns). For T <sub>AA</sub> = 55 ns, improved t <sub>LZWE</sub> min. from 5 ns to 10 ns. Changed upper spec. for Supply Voltage to Ground Potential to V <sub>CCMAX</sub> + 0.5V. Changed upper spec for DC Voltage Applied to Ouputs in High-Z State and DC Input Voltage to V <sub>CC</sub> + 0.3V.