



2M (128K x 16) Static RAM

Features

- **Very high speed: 55 ns and 70 ns**
- **Voltage range:**
 - CY62137CV25: 2.2V–2.7V
 - CY62137CV30: 2.7V–3.3V
 - CY62137CV33: 3.0V–3.6V
 - CY62137CV: 2.7V–3.6V
- **Pin-compatible with the CY62137V**
- **Ultra-low active power**
 - Typical active current: 1.5 mA @ f = 1 MHz
 - Typical active current: 5.5 mA @ f = f_{max} (70-ns speed)
- **Low and ultra-low standby power**
- **Easy memory expansion with CE and OE features**
- **Automatic power-down when deselected**
- **CMOS for optimum speed/power**
- **Packages offered in a 48-ball FBGA**

Functional Description^[1]

The CY62137CV25/30/33 and CY62137CV are high-performance CMOS static RAMs organized as 128K words by 16 bits. These devices feature advanced circuit design to provide ultra-low active current. This is ideal for providing More Battery

Life™ (MoBL®) in portable applications such as cellular telephones. The devices also has an automatic power-down feature that significantly reduces power consumption by 80% when addresses are not toggling. The device can also be put into standby mode reducing power consumption by more than 99% when deselected (CE HIGH or both BLE and BHE are HIGH). The input/output pins (I/O₀ through I/O₁₅) are placed in a high-impedance state when: deselected (CE HIGH), outputs are disabled (OE HIGH), both Byte High Enable and Byte Low Enable are disabled (BHE, BLE HIGH), or during a write operation (CE LOW, and WE LOW).

Writing to the device is accomplished by taking Chip Enable (CE) and Write Enable (WE) inputs LOW. If Byte Low Enable (BLE) is LOW, then data from I/O pins (I/O₀ through I/O₇), is written into the location specified on the address pins (A₀ through A₁₆). If Byte High Enable (BHE) is LOW, then data from I/O pins (I/O₈ through I/O₁₅) is written into the location specified on the address pins (A₀ through A₁₆).

Reading from the device is accomplished by taking Chip Enable (CE) and Output Enable (OE) LOW while forcing the Write Enable (WE) HIGH. If Byte Low Enable (BLE) is LOW, then data from the memory location specified by the address pins will appear on I/O₀ to I/O₇. If Byte High Enable (BHE) is LOW, then data from memory will appear on I/O₈ to I/O₁₅. See the truth table at the back of this data sheet for a complete description of read and write modes.

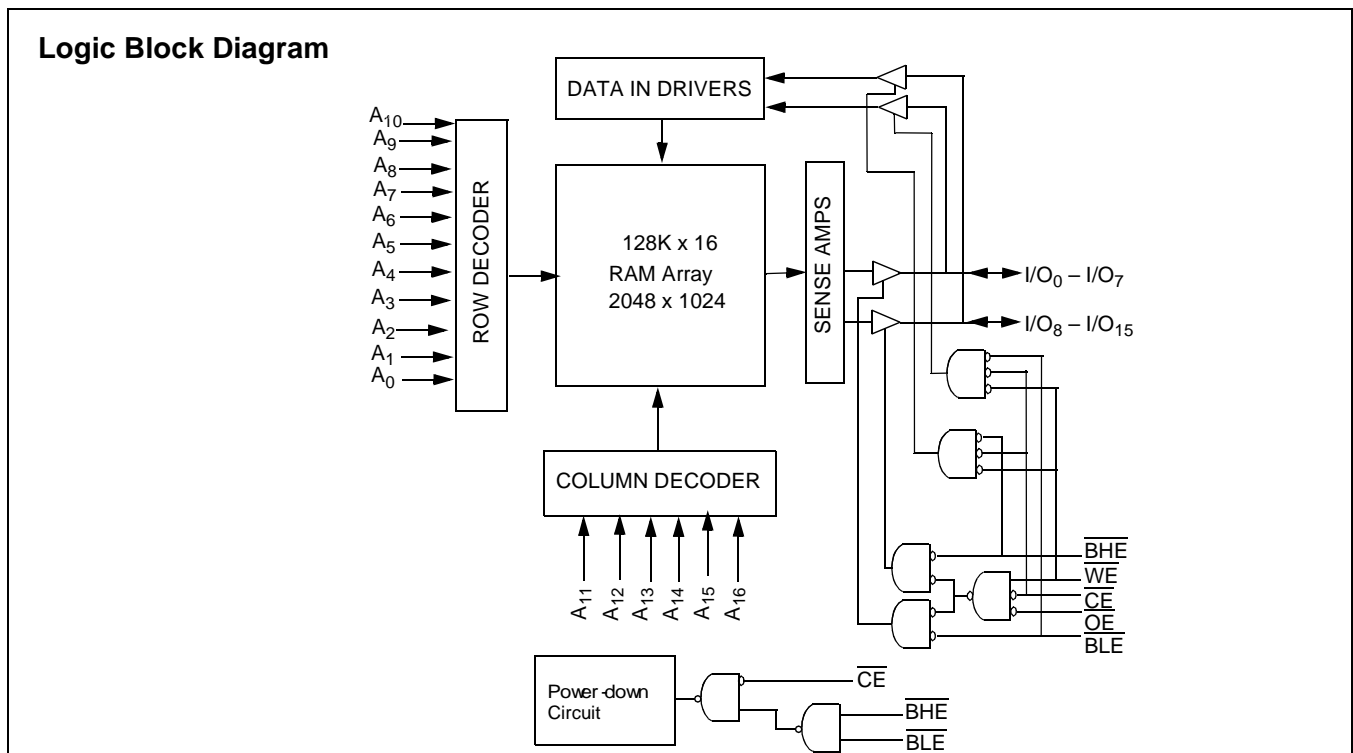

Note:

1. For best practice recommendations, please refer to the Cypress application note "System Design Guidelines" on <http://www.cypress.com>.

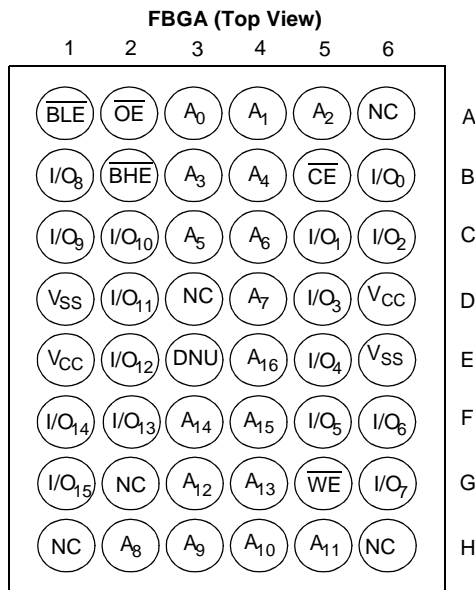
Pin Configuration^[2, 3]

Maximum Ratings

(Above which the useful life may be impaired. For user guidelines, not tested.)

Storage Temperature -65°C to +150°C

Ambient Temperature with Power Applied..... -55°C to +125°C

Supply Voltage to Ground Potential -0.5V to V_{CCMAX} + 0.5V

DC Voltage Applied to Outputs in High-Z State^[4] -0.5V to V_{CC} + 0.3V

DC Input Voltage^[4] -0.5V to V_{CC} + 0.3V

Output Current into Outputs (LOW) 20 mA

Static Discharge Voltage..... > 2001V (per MIL-STD-883, Method 3015)

Latch-up Current > 200 mA

Operating Range

Device	Range	Ambient Temperature T _A	V _{CC}
CY62137CV25	Industrial	-40°C to +85°C	2.2V to 2.7V
CY62137CV30			2.7V to 3.3V
CY62137CV33			3.0V to 3.6V
CY62137CV			2.7V to 3.6V

Product Portfolio

Product	V _{CC} Range (V)			Speed (ns)	Power Dissipation					
					Operating, I _{CC} (mA)				Standby, I _{SB2} (μA)	
	V _{CC(min.)}	V _{CC(typ.)} ^[5]	V _{CC(max.)}		f = 1 MHz		f = f _{max}			
					Typ. ^[5]	Max.	Typ. ^[5]	Max.	Typ. ^[5]	Max.
CY62137CV25LL	2.2	2.5	2.7	55	1.5	3	7	15	2	10
				70	1.5	3	5.5	12		
CY62137CV30LL	2.7	3.0	3.3	55	1.5	3	7	15	2	10
				70	1.5	3	5.5	12		
CY62137CV33LL	3.0	3.3	3.6	55	1.5	3	7	15	5	15
				70	1.5	3	5.5	12		
CY62137CVLL	2.7V	3.3	3.6	70	1.5	3	5.5	12	5	15
CY62137CVSL	2.7V	3.3	3.6	70	1.5	3	5.5	12	1	5

Notes:

2. NC pins are not connected to the die.
3. E3 (DNU) can be left as NC or V_{SS} to ensure proper application.
4. V_{L(min.)} = -2.0V for pulse durations less than 20 ns.
5. Typical values are included for reference only and are not guaranteed or tested. Typical values are measured at V_{CC} = V_{CC(typ.)}, T_A = 25°C.



Electrical Characteristics Over the Operating Range

Parameter	Description	Test Conditions		CY62137CV25-55			CY62137CV25-70			Unit
				Min.	Typ. ^[5]	Max.	Min.	Typ. ^[5]	Max.	
V _{OH}	Output HIGH Voltage	I _{OH} = -0.1 mA	V _{CC} = 2.2V	2.0			2.0			V
V _{OL}	Output LOW Voltage	I _{OL} = 0.1 mA	V _{CC} = 2.2V			0.4			0.4	V
V _{IH}	Input HIGH Voltage			1.8		V _{CC} + 0.3V	1.8		V _{CC} + 0.3V	V
V _{IL}	Input LOW Voltage			-0.3		0.6	-0.3		0.6	V
I _{Ix}	Input Leakage Current	GND ≤ V _I ≤ V _{CC}		-1		+1	-1		+1	μA
I _{OZ}	Output Leakage Current	GND ≤ V _O ≤ V _{CC} , Output Disabled		-1		+1	-1		+1	μA
I _{CC}	V _{CC} Operating Supply Current	f = f _{MAX} = 1/t _{RC}	V _{CC} = 2.7V I _{OUT} = 0 mA CMOS Levels		7	15		5.5	12	mA
		f = 1 MHz			1.5	3		1.5	3	
I _{SB1}	Automatic CE Power-down Current—CMOS Inputs	CE ≥ V _{CC} - 0.2V V _{IN} ≥ V _{CC} - 0.2V or V _{IN} ≤ 0.2V, f = f _{max} (Address and Data Only), f=0 (OE, WE, BHE, and BLE)			2	10		2	10	μA
I _{SB2}	Automatic CE Power-down Current—CMOS Inputs	CE ≥ V _{CC} - 0.2V V _{IN} ≥ V _{CC} - 0.2V or V _{IN} ≤ 0.2V, f = 0, V _{CC} = 2.7V								

Parameter	Description	Test Conditions		CY62137CV30-55			CY62137CV30-70			Unit
				Min.	Typ. ^[5]	Max.	Min.	Typ. ^[5]	Max.	
V _{OH}	Output HIGH Voltage	I _{OH} = -1.0 mA	V _{CC} = 2.7V	2.4			2.4			V
V _{OL}	Output LOW Voltage	I _{OL} = 2.1 mA	V _{CC} = 2.7V			0.4			0.4	V
V _{IH}	Input HIGH Voltage			2.2		V _{CC} + 0.3V	2.2		V _{CC} + 0.3V	V
V _{IL}	Input LOW Voltage			-0.3		0.8	-0.3		0.8	V
I _{Ix}	Input Leakage Current	GND ≤ V _I ≤ V _{CC}		-1		+1	-1		+1	μA
I _{OZ}	Output Leakage Current	GND ≤ V _O ≤ V _{CC} , Output Disabled		-1		+1	-1		+1	μA
I _{CC}	V _{CC} Operating Supply Current	f = f _{MAX} = 1/t _{RC}	V _{CC} = 3.3V I _{OUT} = 0 mA CMOS Levels		7	15		5.5	12	mA
		f = 1 MHz			1.5	3		1.5	3	
I _{SB1}	Automatic CE Power-down Current—CMOS Inputs	CE ≥ V _{CC} - 0.2V V _{IN} ≥ V _{CC} - 0.2V or V _{IN} ≤ 0.2V, f = f _{max} (Address and Data Only), f=0 (OE, WE, BHE, and BLE)			2	10		2	10	μA
I _{SB2}	Automatic CE Power-down Current—CMOS Inputs	CE ≥ V _{CC} - 0.2V V _{IN} ≥ V _{CC} - 0.2V or V _{IN} ≤ 0.2V, f = 0, V _{CC} = 3.3V								

Electrical Characteristics Over the Operating Range

Parameter	Description	Test Conditions		CY62137CV33-55			CY62137CV33-70 CY62137CV-70			Unit
				Min.	Typ. ^[5]	Max.	Min.	Typ. ^[5]	Max.	
V _{OH}	Output HIGH Voltage	I _{OH} = -1.0 mA	V _{CC} = 3.0V	2.4			2.4			V
			V _{CC} = 2.7V				2.4			V
V _{OL}	Output LOW Voltage	I _{OL} = 2.1 mA	V _{CC} = 3.0V			0.4			0.4	V
			V _{CC} = 2.7V						0.4	V

Electrical Characteristics Over the Operating Range (continued)

Parameter	Description	Test Conditions	CY62137CV33-55			CY62137CV33-70 CY62137CV-70			Unit	
			Min.	Typ. ^[5]	Max.	Min.	Typ. ^[5]	Max.		
V _{IH}	Input HIGH Voltage		2.2		V _{CC} + 0.3V	2.2		V _{CC} + 0.3V	V	
V _{IL}	Input LOW Voltage		-0.3		0.8	-0.3		0.8	V	
I _{Ix}	Input Leakage Current	GND ≤ V _I ≤ V _{CC}	-1		+1	-1		+1	μA	
I _{OZ}	Output Leakage Current	GND ≤ V _O ≤ V _{CC} , Output Disabled	-1		+1	-1		+1	μA	
I _{CC}	V _{CC} Operating Supply Current	f = f _{MAX} = 1/t _{RC} f = 1 MHz		V _{CC} = 3.6V I _{OUT} = 0 mA CMOS Levels	7	15		5.5	12	mA
					1.5	3		1.5	3	
I _{SB1}	Automatic CE Power-down Current —CMOS Inputs	CE ≥ V _{CC} - 0.2V V _{IN} ≥ V _{CC} - 0.2V or V _{IN} ≤ 0.2V, f = f _{max} (Address and Data Only), f = 0 (OE, WE, BHE, and BLE)		5	15		5	15	μA	
I _{SB2}	Automatic CE Power-down Current —CMOS Inputs	CE ≥ V _{CC} - 0.2V V _{IN} ≥ V _{CC} - 0.2V or V _{IN} ≤ 0.2V, f = 0, V _{CC} = 3.6V	LL	5	15	SL	5	15		
						1				5

Capacitance^[6]

Parameter	Description	Test Conditions	Max.	Unit
C _{IN}	Input Capacitance	T _A = 25°C, f = 1 MHz,	6	pF
C _{OUT}	Output Capacitance	V _{CC} = V _{CC(typ.)}	8	pF

Thermal Resistance

Parameter	Description	Test Conditions	BGA	Unit
θ _{JA}	Thermal Resistance (Junction to Ambient) ^[6]	Still Air, soldered on a 3 x 4.5 inch, two-layer printed circuit board	55	°C/W
θ _{JC}	Thermal Resistance (Junction to Case) ^[6]		16	°C/W

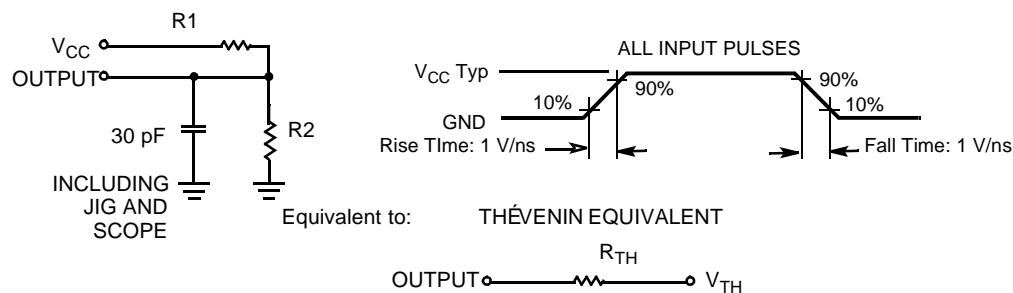
AC Test Loads and Waveforms

Parameters	2.5V	3.0V	3.3V	Unit
R ₁	16600	1105	1216	Ω
R ₂	15400	1550	1374	Ω
R _{TH}	8000	645	645	Ω
V _{TH}	1.20	1.75	1.75	V

Note:

6. Tested initially and after any design or process changes that may affect these parameters.

Data Retention Characteristics (Over the Operating Range)

Parameter	Description	Conditions	Min.	Typ. ^[5]	Max.	Unit
V_{DR}	V_{CC} for Data Retention		1.5		V_{CCmax}	V
I_{CCDR}	Data Retention Current	$V_{CC} = 1.5V$ $\overline{CE} \geq V_{CC} - 0.2V$, $V_{IN} \geq V_{CC} - 0.2V$ or $V_{IN} \leq 0.2V$	LL	1	6	μA
			SL		4	
$t_{CDR}^{[6]}$	Chip Deselect to Data Retention Time		0			ns
$t_R^{[7]}$	Operation Recovery Time		t_{RC}			ns

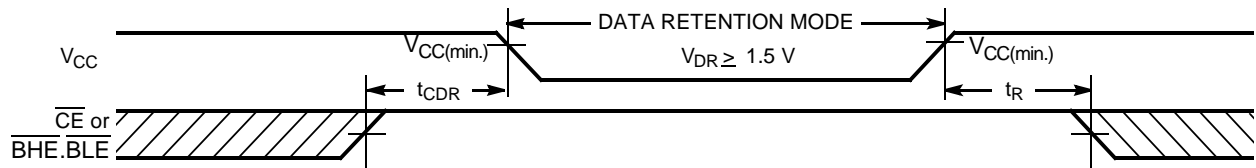
Data Retention Waveform^[8]

Switching Characteristics Over the Operating Range^[9]

Parameter	Description	55 ns		70 ns		Unit
		Min	Max	Min	Max	
Read Cycle						
t_{RC}	Read Cycle Time	55		70		ns
t_{AA}	Address to Data Valid		55		70	ns
t_{OHA}	Data Hold from Address Change	10		10		ns
t_{ACE}	\overline{CE} LOW to Data Valid		55		70	ns
t_{DOE}	\overline{OE} LOW to Data Valid		25		35	ns
t_{LZOE}	\overline{OE} LOW to Low-Z ^[10]	5		5		ns
t_{HZOE}	\overline{OE} HIGH to High-Z ^[10, 12]		20		25	ns
t_{LZCE}	\overline{CE} LOW to Low-Z ^[10]	10		10		ns
t_{HZCE}	\overline{CE} HIGH to High-Z ^[10, 12]		20		25	ns
t_{PU}	\overline{CE} LOW to Power-up	0		0		ns
t_{PD}	\overline{CE} HIGH to Power-down		55		70	ns
t_{DBE}	$\overline{BHE}/\overline{BLE}$ LOW to Data Valid		55		70	ns
$t_{LZBE}^{[11]}$	$\overline{BHE}/\overline{BLE}$ LOW to Low-Z ^[10]	5		5		ns
t_{HZBE}	$\overline{BHE}/\overline{BLE}$ HIGH to High-Z ^[10, 12]		20		25	ns
Write Cycle^[13]						
t_{WC}	Write Cycle Time	55		70		ns
t_{SCE}	\overline{CE} LOW to Write End	45		60		ns

Notes:

- Full-device AC operation requires linear V_{CC} ramp from V_{DR} to $V_{CC(min.)} > 100 \mu s$ or stable at $V_{CC(min.)} > 100 \mu s$.
- $\overline{BHE}/\overline{BLE}$ is the AND of both \overline{BHE} and \overline{BLE} . Chip can be deselected by either disabling the chip enable signals or by disabling both \overline{BHE} and \overline{BLE} .
- Test conditions assume signal transition time of 5 ns or less, timing reference levels of $V_{CC(typ.)}/2$, input pulse levels of 0 to $V_{CC(typ.)}$, and output loading of the specified I_{OL}/I_{OH} and 30-pF load capacitance.
- At any given temperature and voltage condition, t_{HZCE} is less than t_{LZCE} , t_{HZBE} is less than t_{LZBE} , t_{HZOE} is less than t_{LZOE} , and t_{HZWE} is less than t_{LZWE} for any given device.
- If both byte enables are toggled together this value is 10 ns.
- t_{HZOE} , t_{HZCE} , t_{HZBE} , and t_{HZWE} transitions are measured when the outputs enter a high impedance state.
- The internal write time of the memory is defined by the overlap of \overline{WE} , $\overline{CE} = V_{IL}$, \overline{BHE} and/or $\overline{BLE} = V_{IL}$. All signals must be ACTIVE to initiate a write and any of these signals can terminate a write by going INACTIVE. The data input set-up and hold timing should be referenced to the edge of the signal that terminates the write.

Switching Characteristics Over the Operating Range^[9] (continued)

Parameter	Description	55 ns		70 ns		Unit
		Min	Max	Min	Max	
t_{AW}	Address Set-up to Write End	45		60		ns
t_{HA}	Address Hold from Write End	0		0		ns
t_{SA}	Address Set-up to Write Start	0		0		ns
t_{PWE}	\overline{WE} Pulse Width	40		45		ns
t_{BW}	$\overline{BHE}/\overline{BLE}$ Pulse Width	50		60		ns
t_{SD}	Data Set-up to Write End	25		30		ns
t_{HD}	Data Hold from Write End	0		0		ns
t_{HZWE}	\overline{WE} LOW to High-Z ^[10, 12]		20		25	ns
t_{LZWE}	\overline{WE} HIGH to Low-Z ^[10]	10		10		ns

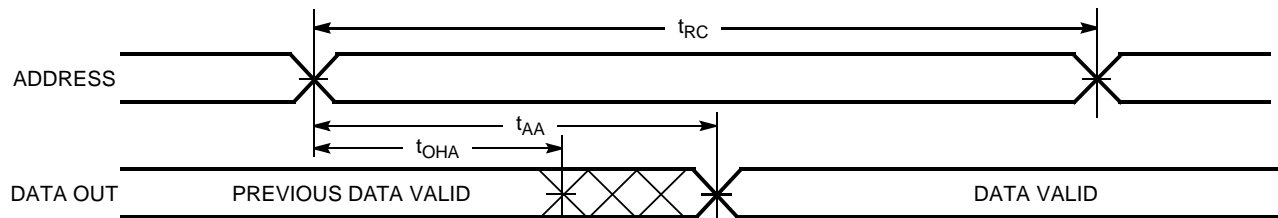
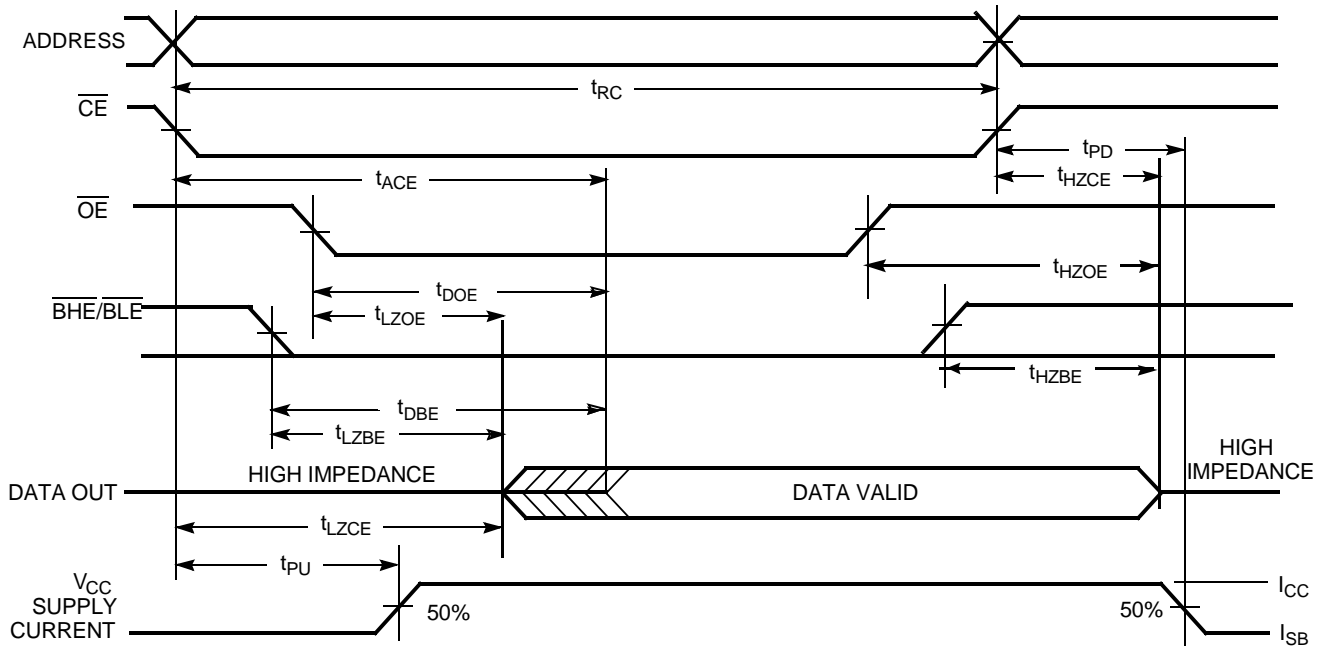
Switching Waveforms
Read Cycle No. 1 (Address Transition Controlled)^[14, 15]

Read Cycle No. 2 (\overline{OE} Controlled)^[15, 16]

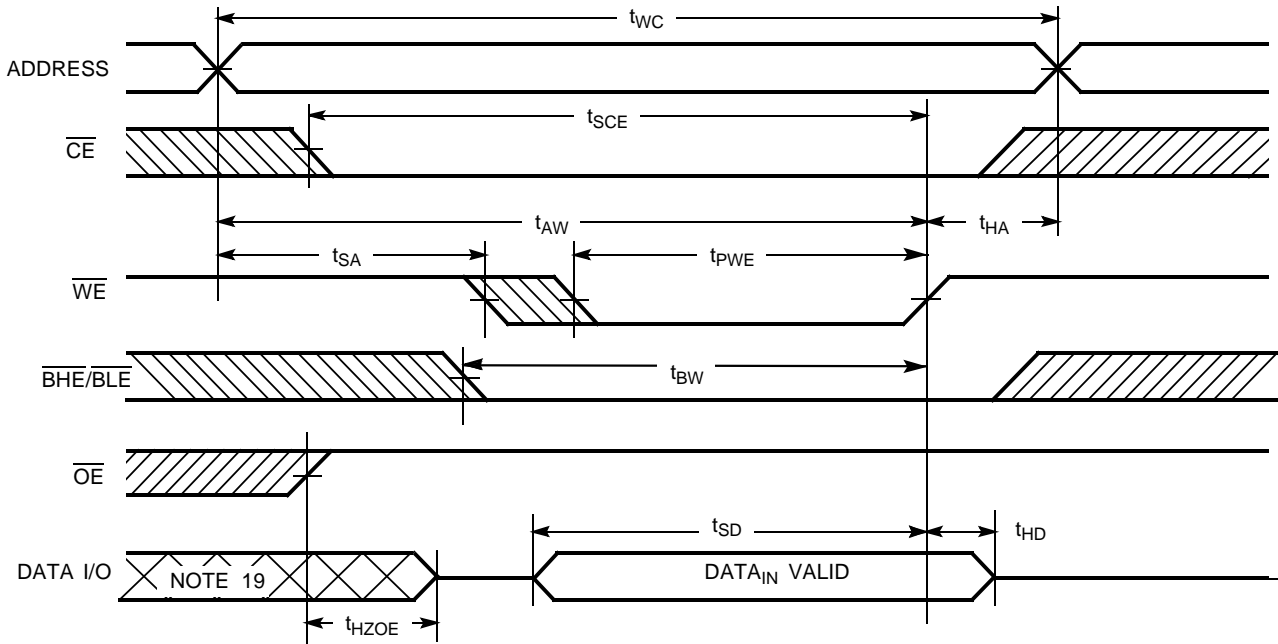
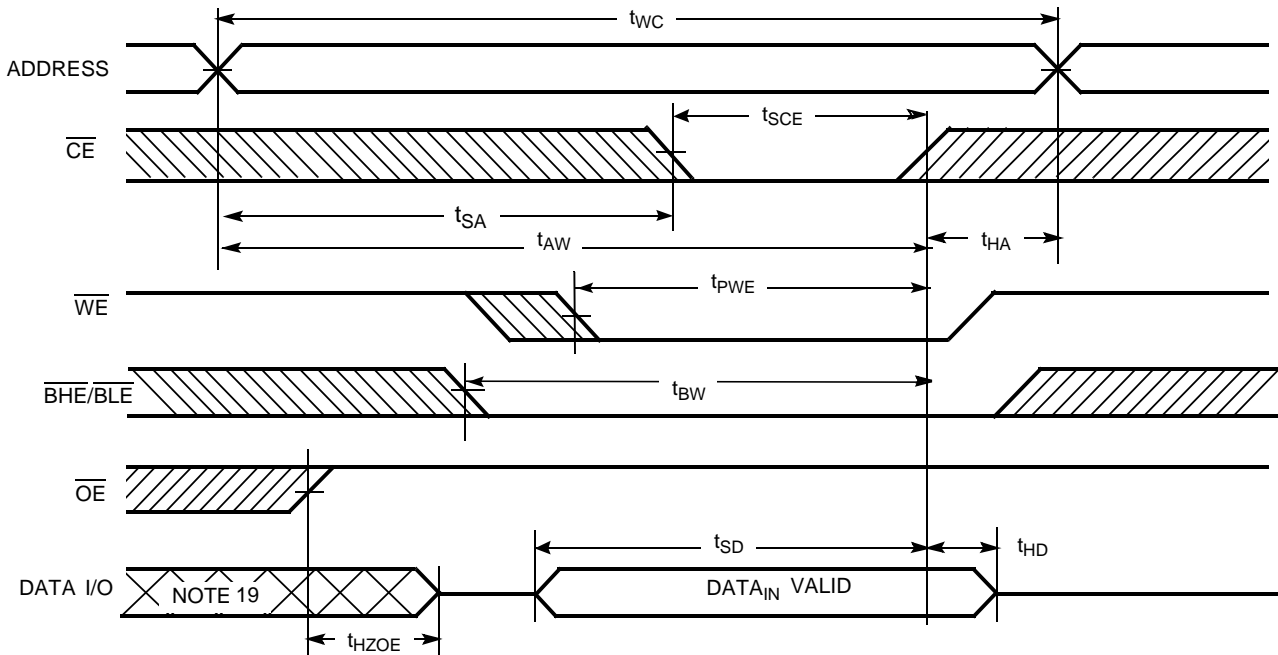
Notes:

14. Device is continuously selected. \overline{OE} , \overline{CE} = V_{IL} , \overline{BHE} , \overline{BLE} = V_{IL} .
15. \overline{WE} is HIGH for read cycle.
16. Address valid prior to or coincident with \overline{CE} , \overline{BHE} , \overline{BLE} transition LOW.

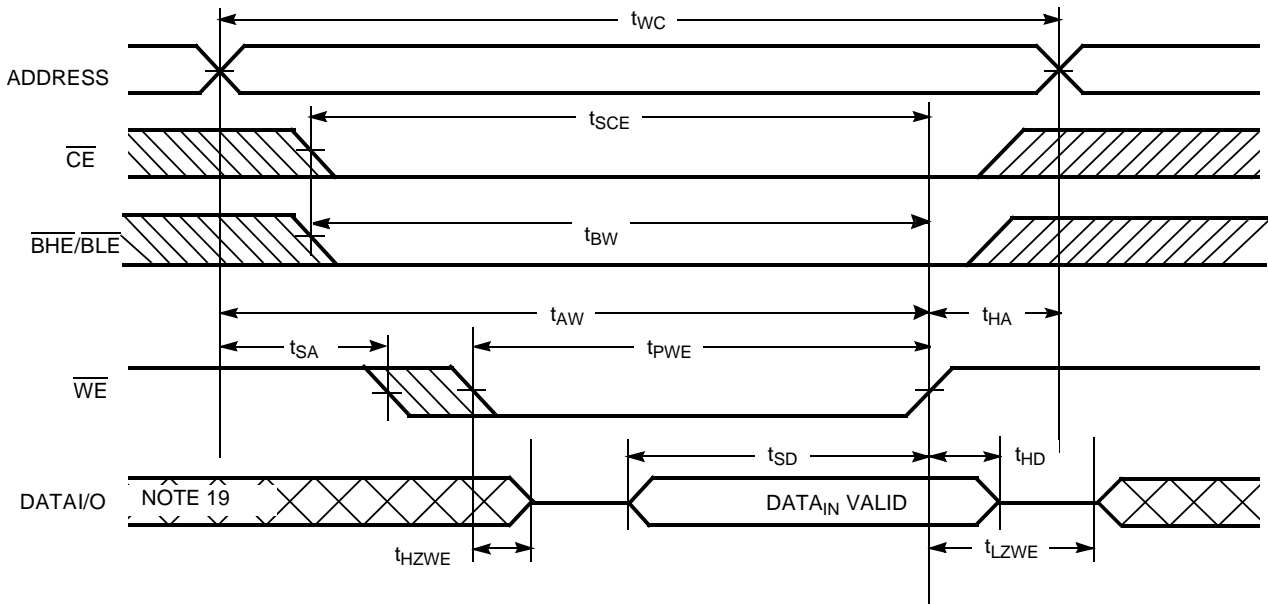
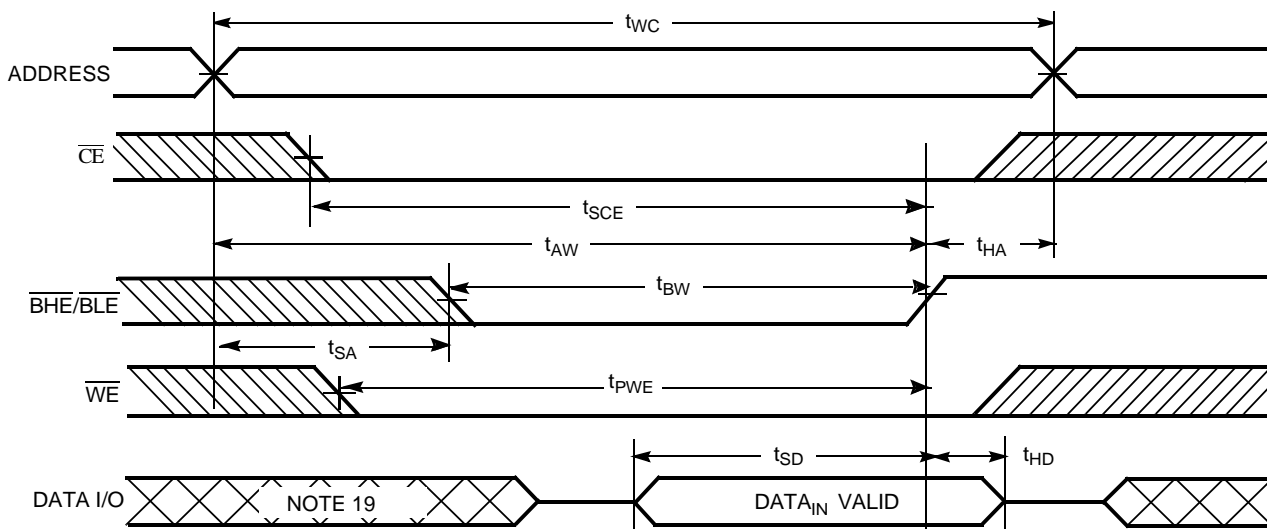
Switching Waveforms (continued)
Write Cycle No. 1 (\overline{WE} Controlled) ^[13, 17, 18]

Write Cycle No. 2 (\overline{CE} Controlled) ^[13, 17, 18]

Notes:

17. Data I/O is high-impedance if $\overline{OE} = V_{IH}$.
18. If \overline{CE} goes HIGH simultaneously with \overline{WE} HIGH, the output remains in a high-impedance state.
19. During this period, the I/Os are in output state and input signals should not be applied.

Switching Waveforms (continued)
Write Cycle No. 3 (\overline{WE} Controlled, \overline{OE} LOW)^[18]

Write Cycle No. 4 ($\overline{BHE}/\overline{BLE}$ Controlled, \overline{OE} LOW)^[18]

Typical DC and AC Parameters

(Typical values are included for reference only and are not guaranteed or tested. Typical values are measured at $V_{CC} = V_{CC(typ)}$, $T_A = 25^\circ\text{C}$)

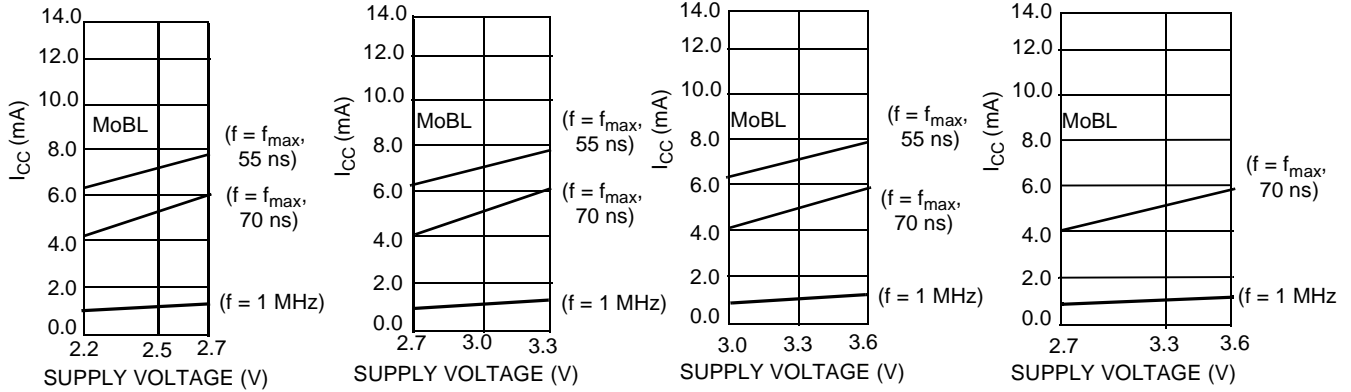
Operating Current vs. Supply Voltage



Standby Current vs. Supply Voltage

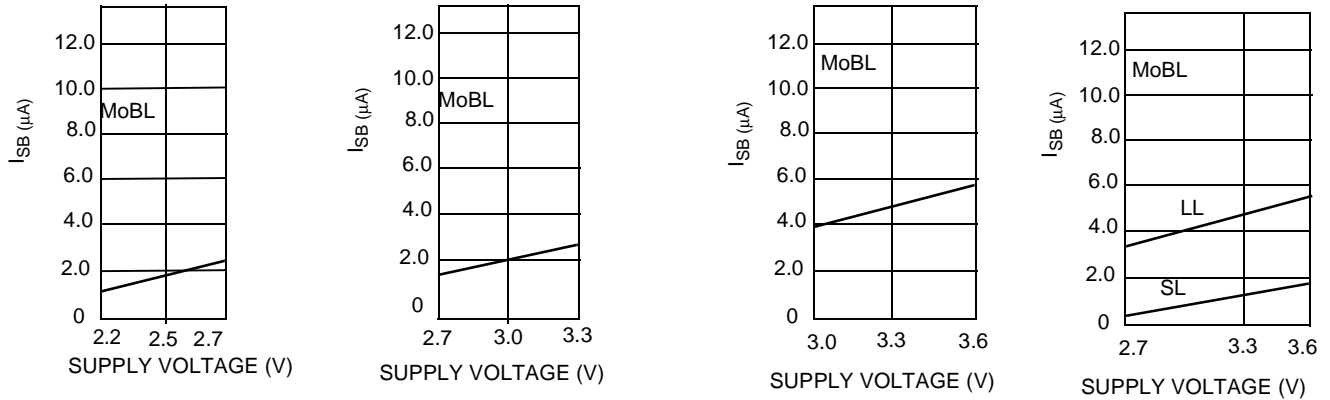

Access Time vs. Supply Voltage

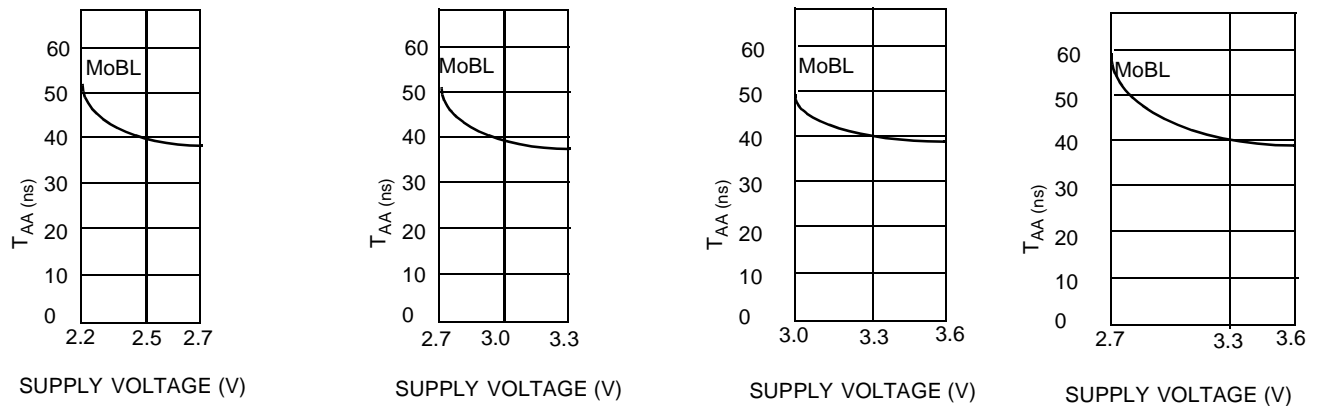



Truth Table

\overline{CE}	\overline{WE}	\overline{OE}	\overline{BHE}	\overline{BLE}	Inputs/Outputs	Mode	Power
H	X	X	X	X	High-Z	Deselect/Power-down	Standby (I_{SB})
X	X	X	H	H	High-Z	Deselect/Power-down	Standby (I_{SB})
L	H	L	L	L	Data Out (I/O_0 – I/O_{15})	Read	Active (I_{CC})
L	H	L	H	L	Data Out (I/O_0 – I/O_7); I/O_8 – I/O_{15} in High-Z	Read	Active (I_{CC})
L	H	L	L	H	Data Out (I/O_8 – I/O_{15}); I/O_0 – I/O_7 in High-Z	Read	Active (I_{CC})
L	H	H	L	L	High-Z	Output Disabled	Active (I_{CC})
L	H	H	H	L	High-Z	Output Disabled	Active (I_{CC})
L	H	H	L	H	High-Z	Output Disabled	Active (I_{CC})
L	L	X	L	L	Data In (I/O_0 – I/O_{15})	Write	Active (I_{CC})
L	L	X	H	L	Data In (I/O_0 – I/O_7); I/O_8 – I/O_{15} in High-Z	Write	Active (I_{CC})
L	L	X	L	H	Data In (I/O_8 – I/O_{15}); I/O_0 – I/O_7 in High-Z	Write	Active (I_{CC})

Ordering Information

Speed (ns)	Ordering Code	Voltage Range (V)	Package Name	Package Type	Operating Range
70	CY62137CV25LL-70BAI	2.2–2.7	BA48A	48-ball Fine Pitch BGA (7 mm x 7 mm x 1.2 mm)	Industrial
	CY62137CV25LL-70BVI	2.2–2.7	BV48A	48-ball Fine Pitch BGA (6 mm x 8 mm x 1 mm)	
	CY62137CV30LL-70BAI	2.7–3.3	BA48A	48-ball Fine Pitch BGA (7 mm x 7 mm x 1.2 mm)	
	CY62137CV30LL-70BVI	2.7–3.3	BV48A	48-ball Fine Pitch BGA (6 mm x 8 mm x 1 mm)	
	CY62137CV33LL-70BAI	3.0–3.6	BA48A	48-ball Fine Pitch BGA (7 mm x 7 mm x 1.2 mm)	
	CY62137CV33LL-70BVI	3.0–3.6	BV48A	48-ball Fine Pitch BGA (6 mm x 8 mm x 1 mm)	
	CY62137CVLL-70BAI	2.7–3.6	BA48A	48-ball Fine Pitch BGA (7 mm x 7 mm x 1.2 mm)	
	CY62137CVLL-70BVI	2.7–3.6	BV48A	48-ball Fine Pitch BGA (6 mm x 8 mm x 1 mm)	
	CY62137CVSL-70BAI	2.7–3.6	BA48A	48-ball Fine Pitch BGA (7 mm x 7 mm x 1.2 mm)	
	CY62137CVSL-70BVI	2.7–3.6	BV48A	48-ball Fine Pitch BGA (6 mm x 8 mm x 1 mm)	
55	CY62137CV25LL-55BAI	2.2–2.7	BA48A	48-ball Fine Pitch BGA (7 mm x 7 mm x 1.2 mm)	
	CY62137CV25LL-55BVI	2.2–2.7	BV48A	48-ball Fine Pitch BGA (6 mm x 8 mm x 1 mm)	
	CY62137CV30LL-55BAI	2.7–3.3	BA48A	48-ball Fine Pitch BGA (7 mm x 7 mm x 1.2 mm)	
	CY62137CV30LL-55BVI	2.7–3.3	BV48A	48-ball Fine Pitch BGA (6 mm x 8 mm x 1 mm)	
	CY62137CV33LL-55BAI	3.0–3.6	BA48A	48-ball Fine Pitch BGA (7 mm x 7 mm x 1.2 mm)	
	CY62137CV33LL-55BVI	3.0–3.6	BV48A	48-ball Fine Pitch BGA (6 mm x 8 mm x 1 mm)	

Package Diagrams

48-ball (7.00 mm x 7.00 mm x 1.2 mm) FBGA BA48A

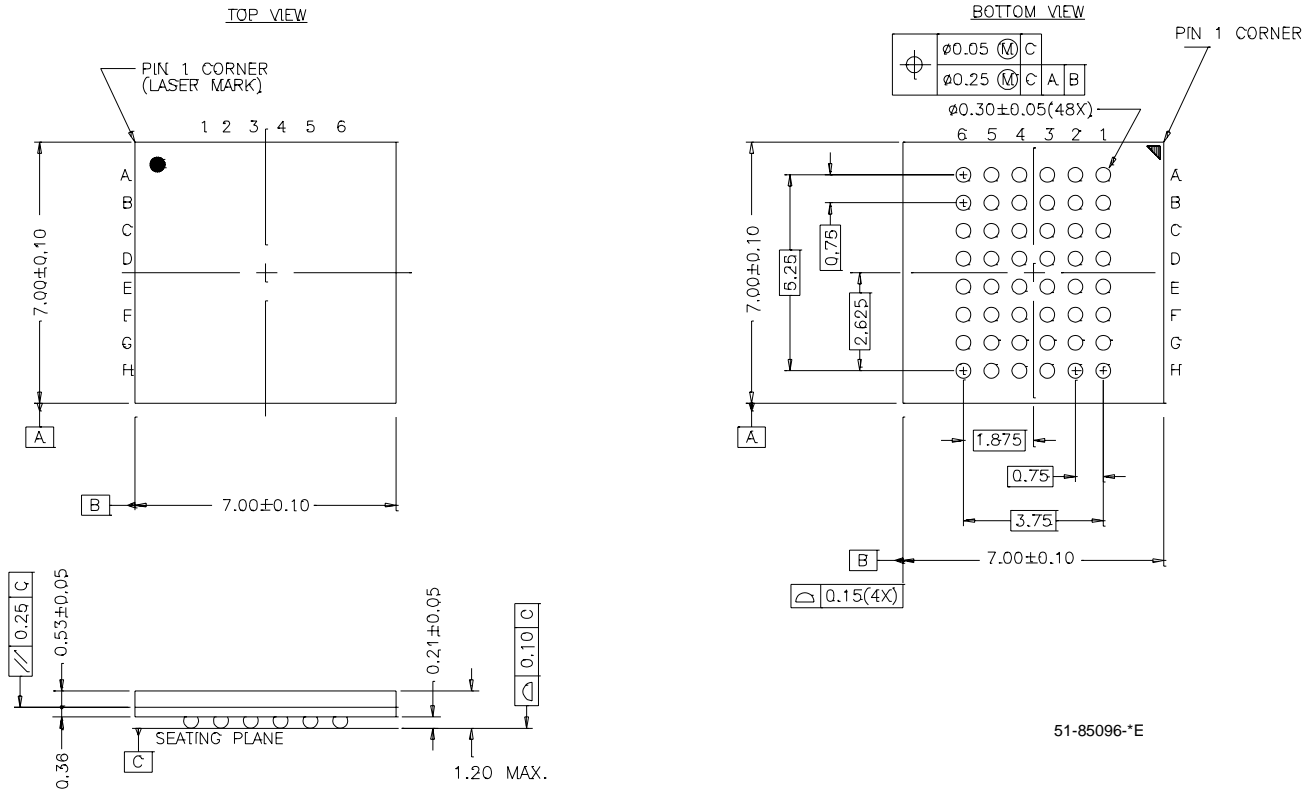

51-85096*E

Package Diagrams (continued)

48-ball VFBGA (6 x 8 x 1 mm) BV48A

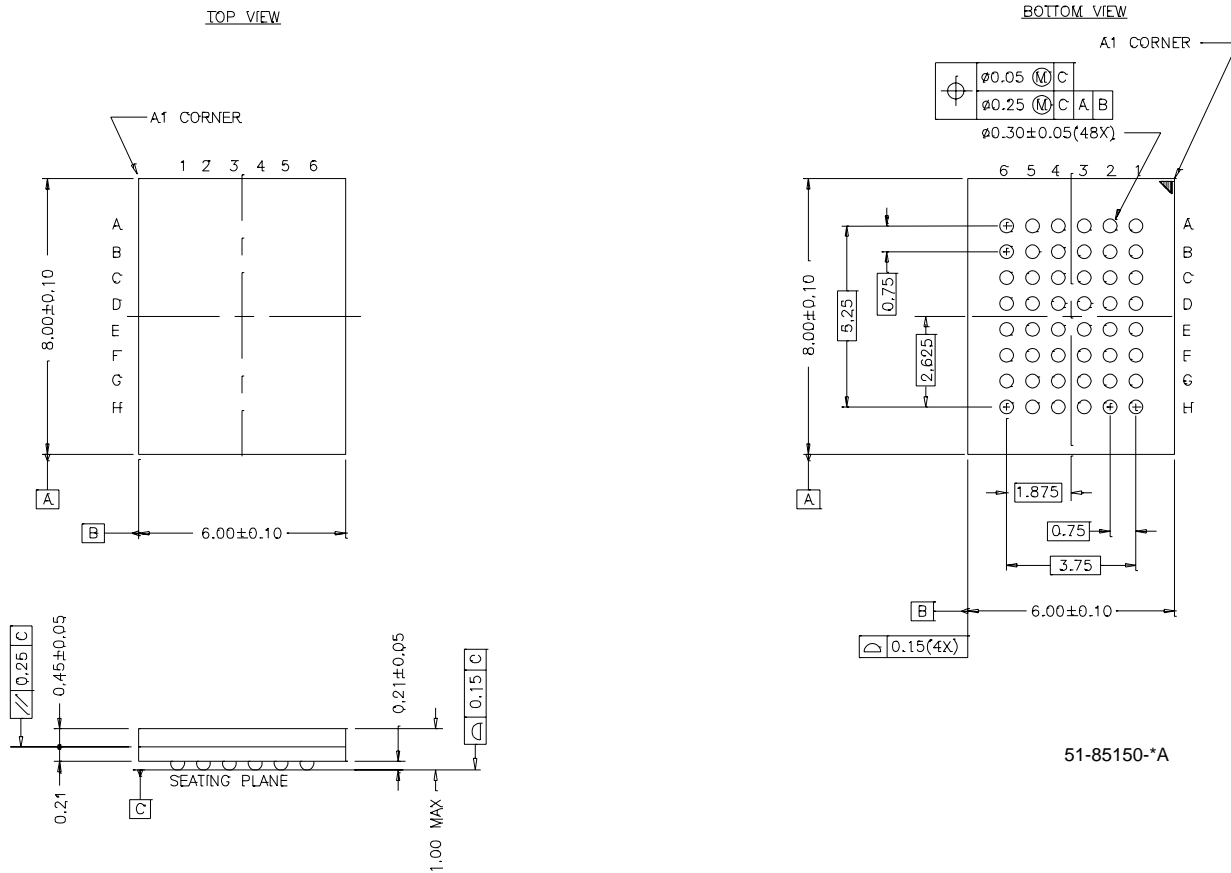

51-85150-*A

MoBL is a registered trademark and More Battery Life is a trademark of Cypress Semiconductor Corporation. All product and company names mentioned in this document may be the trademarks of their respective holders.



Document History Page

Document Title: CY62137CV25/30/33 MoBL [®] and CY62137CV MoBL [®] 2M (128K x 16) Static RAM				
Document Number: 38-05201				
REV.	ECN NO.	Issue Date	Orig. of Change	Description of Change
**	112393	02/19/02	GAV	New Data Sheet (advance information)
*A	114015	04/25/02	JUI	Added BV package diagram Changed from Advance Information to Preliminary
*B	117064	07/12/02	MGN	Changed from Preliminary to Final
*C	118122	09/10/02	MGN	Added new part number: CY62137CV with wider voltage (2.7V – 3.6V). Added new SL power bin for new part number. For T _{AA} = 55 ns, improved t _{PWE} min. from 45 ns to 40 ns. For T _{AA} = 70 ns, improved t _{PWE} min. from 50 ns to 45 ns. For T _{AA} = 70 ns, improved t _{LZWE} min. from 5 ns to 10 ns.
*D	118761	09/23/02	MGN	Improved Typ. I _{CC} spec to 7 mA (for 55 ns) and 5.5 mA (for 70 ns). Improved Max I _{CC} spec to 15 mA (for 55 ns) and 12 mA (for 70 ns). For T _{AA} = 55 ns, improved t _{LZWE} min. from 5 ns to 10 ns. Changed upper spec. for Supply Voltage to Ground Potential to V _{CCMAX} + 0.5V. Changed upper spec. for DC Voltage Applied to Outputs in High-Z State and DC Input Voltage to V _{CC} + 0.3V.