



CTA/CTB16

16Amp - 400/600/800/1000V - TRIAC

Applications

- Phase Control
- Static Switching
- Light Dimming
- Motor Speed Control
- Kitchen Equipment
- Power Tools
- Solenoid Valve Controls:
 - Dishwasher
 - Washing Machines

- > Suitable for General Purpose AC Switching
- > Alternistor/No Snubber Versions for Inductive Loads
- > Logic Level Available for use with Microcontrollers and Low Level Devices
- > IGT Range 10-50 mA (Q1)
- > V_{DRM}/V_{RMM} 400, 600, 800, 1000V

Absolute Maximum Ratings

	CONDITIONS	SYMBOL	RATING
RMS On-State Current (full sine wave)	$T_c = 100^\circ\text{C}$ $T_c = 85^\circ\text{C}$	TO-220AB TO-220AB Iso $I_{T(RMS)}$	16A
Non Repetitive Surge Peak On-State Current (Full Cycle, T_j Initial = 25°C)	F = 50 Hz F = 60 Hz	I_{TSM}	160A 168A
I^2t Value for fusing	$t_p = 10$ ms	I^2t	144A ² s
Critical rate of rise of on-state current $I_G = 2 \times I_{GT}$, $t_r < 100$ ns, $T_j = 125^\circ\text{C}$		di/dt	100A/ μ s
Peak Gate Current @ $T_j = 125^\circ\text{C}$	$t_p = 20$ μ s	I_{GM}	4A
Average Gate Power Dissipation @ $T_j = 125^\circ\text{C}$		$P_{G(AV)}$	1W
Storage Temperature Range		T_{stg}	-40 to +150°C
Operating Junction Temperature Range		T_j	-40 to +125°C
Isolation Voltage (CTA Series only)		V_{ISO}	2500 V_{RMS}

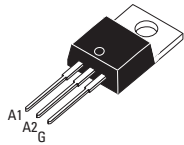

TO-220AB Isolated (CTA16)

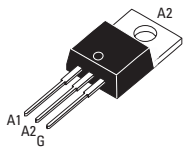

TO-220AB Non-Isolated (CTB16)



Electrical Characteristics

ALTERNISTOR/NO SNUBBER AND LOGIC LEVEL (3 Quadrants)		SW	CW	BW
$I_{GT} \text{ MAX @ } V_D = 12 \text{ V, } R_L = 30\Omega$ NOTE 1	QI-II-III	10mA	35mA	50mA
$V_{GT} \text{ MAX @ } V_D = 12 \text{ V, } R_L = 30\Omega$	QI-II-III	1.3V	1.3V	1.3V
$V_{GD} \text{ MIN @ } V_D = V_{DRM}, R_L = 3.3k\Omega$	$T_j = 125^\circ\text{C}$ QI-II-III	0.2V	0.2V	0.2V
$I_H \text{ MAX @ } I_T = 500 \text{ mA}$ NOTE 2		15mA	35mA	50mA
$I_L \text{ MAX @ } I_G = 1.2 I_{GT}$	QI-III	25mA	50mA	70mA
$I_L \text{ MAX @ } I_G = 1.2 I_{GT}$	Q-II	30mA	60mA	80mA
dv/dt MIN @ $V_D = 67\%V_{DRM}$ (gate open) NOTE 2	$T_j = 125^\circ\text{C}$	40V/ μ s	500V/ μ s	1000V/ μ s
(dv/dt)c MIN @ (dv/dt)c = 0.1 V/ms NOTE 2	$T_j = 125^\circ\text{C}$	8.5A/ms		
(dv/dt)c MIN @ (dv/dt)c = 10 V/ms NOTE 2	$T_j = 125^\circ\text{C}$	3.0A/ms		
(di/dt)c MIN without Snubber NOTE 2	$T_j = 125^\circ\text{C}$		8.5A/ms	14A/ms

STANDARD (4 Quadrants)		C	B
$I_{GT} \text{ MAX @ } V_D = 12 \text{ V, } R_L = 30\Omega$ NOTE 1	QI-II-III	25mA	50mA
$I_{GT} \text{ MAX @ } V_D = 12 \text{ V, } R_L = 30\Omega$ NOTE 1	QIV	50mA	100mA
$V_{GT} \text{ MAX @ } V_D = 12 \text{ V, } R_L = 30\Omega$	Q-AII		1.3V
$V_{GD} \text{ MIN @ } V_D = V_{DRM}, R_L = 3.3k\Omega$	$T_j = 125^\circ\text{C}$ Q-AII		0.2V
$I_H \text{ MAX @ } I_T = 500 \text{ mA}$ NOTE 2		25mA	50mA
$I_L \text{ MAX @ } I_G = 1.2 I_{GT}$	QI-III-IV	40mA	50mA
$I_L \text{ MAX @ } I_G = 1.2 I_{GT}$	Q-II	80mA	100mA
dv/dt MIN @ $V_D = 67\%V_{DRM}$ (gate open) NOTE 2	$T_j = 125^\circ\text{C}$	200V/ μ s	400V/ μ s
(dv/dt)c MIN @ (di/dt)c = 7.0 A/ms NOTE 2	$T_j = 125^\circ\text{C}$	5V/ μ s	10V/ μ s

GENERAL NOTES

1. Minimum IGT is guaranteed at 5% of IGT max.
2. For both polarities of A2 referenced to A1
3. All parameters at 25 degrees C unless otherwise specified.

Static Characteristics

V_T MAX @ $I_{TM} = 22.5$ A, $t_p = 380\mu s$ NOTE 2	$T_j = 25^\circ C$	1.55V
V_{TO} MAX @ Threshold Voltage NOTE 2	$T_j = 125^\circ C$	0.85V
R_d MAX @ Dynamic Resistance NOTE 2	$T_j = 125^\circ C$	25m Ω
I_{DRM} MAX @ $V_{DRM} = V_{RRM}$	$T_j = 25^\circ C$	5 μ A
I_{RRM} MAX @ $V_{DRM} = V_{RRM}$	$T_j = 125^\circ C$	2mA

Thermal Resistances

	SYMBOL	RATING
Junction to Case (AC)	TO-220AB $R_{th(j-c)}$	1.2°C/W
Junction to Case (AC)	TO-220AB Isolated $R_{th(j-c)}$	2.1°C/W
Junction to Ambient	TO-220AB $R_{th(j-a)}$	60°C/W
Junction to Ambient	TO-220AB Isolated $R_{th(j-a)}$	60°C/W

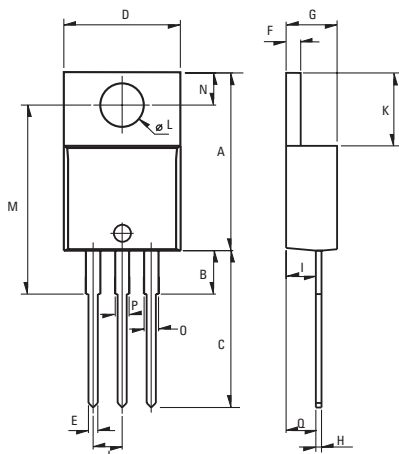

Weight: 2.3g (0.08 oz)

Dimensions

REF.	Millimeters			Inches		
	Min.	Typ.	Max.	Min.	Typ.	Max.
A	15.24		15.75	0.6		0.62
B		3.23			0.127	
C	12.78		13.79	0.503		0.543
D	9.96		10.36	0.392		0.408
E	0.69		0.94	0.027		0.037
F	1.22		1.32	0.048		0.052
G	4.62		4.83	0.182		0.19
H	0.46		0.61	0.018		0.024
I	2.49		2.84	0.098		0.112
J	2.39		2.69	0.094		0.106
K	6.48		6.88	0.255		0.271
L	3.78		3.89	0.149		0.153
M	15.49	16	16.51	0.61	0.63	0.65
N	2.59		2.9	0.102		0.114
O	0.99		1.55	0.039		0.061
P	0.99		1.55	0.039		0.061
Q		2.67			0.105	

Part Number Selection

Part Number	Voltage [Vpk]	I_{GT} [mA]	Type	Package
CTA/CTB16-xxxB	400, 600, 800, 1000	50mA	Standard	TO-220AB
CTA/CTB16-xxxBW	400, 600, 800, 1000	50mA	Alternistor/No Snubber	TO-220AB
CTA/CTB16-xxxC	400, 600, 800, 1000	25mA	Standard	TO-220AB
CTA/CTB16-xxxCW	400, 600, 800, 1000	35mA	Alternistor/No Snubber	TO-220AB
CTA/CTB16-xxxSW	400, 600, 800, 1000	10mA	Logic Level	TO-220AB

Part Number Designation

SERIES
CT

Isolation Type
A: Isolated
B: Non-Isolated

Rated Current
16: 16 Amp

Maximum Blocking Voltage
400: 400Vpk
600: 600Vpk
800: 800Vpk
1000: 1000Vpk

Type
B: Standard ($I_{GT}=50$ mA)
BW: Alternistor/No Snubber ($I_{GT}=50$ mA)
C: Standard ($I_{GT}=25$ mA)
CW: Alternistor/No Snubber ($I_{GT}=35$ mA)
SW: Logic Level ($I_{GT}=10$ mA)

Packaging
Blank: Bulk
PT: Plastic Tube

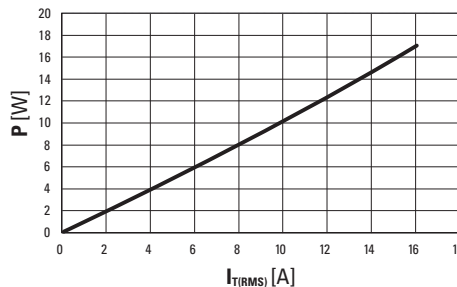

Fig. 1: Power dissipation versus RMS on-state current (full cycle).

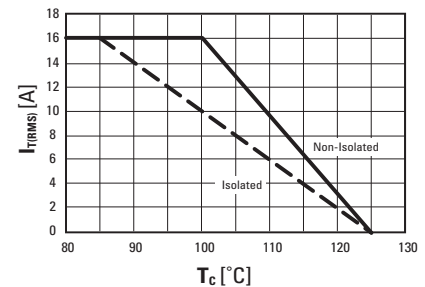

Fig. 2: RMS on-state current versus case temperature (full cycle)

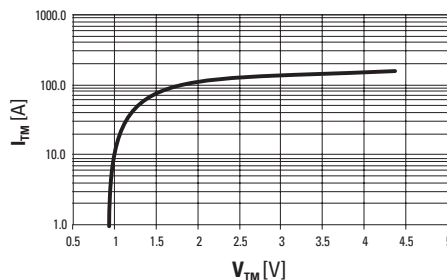

Fig. 3: On-state current versus on-state voltage (instantaneous values)

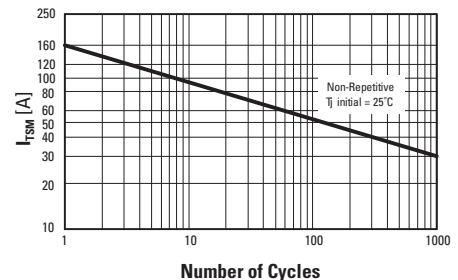

Fig. 4: Non-repetitive surge peak on-state current versus number of cycles.

ISO9001 Certified

Approvals

UL Recognized Component - E72445
(For CTA series)

USA

Sales Support (877) 502-5500
 Tech Support (877) 702-7700
 Fax (619) 710-8540
 Email: sales@crydom.com
 Crydom Corp
 2320 Paseo de las Americas, Suite 201
 San Diego, CA 92154

EUROPE - UK

Telephone +44 (0) 1202 365070
 Fax +44 (0) 1202 365090
 Email: intsales@crydom.com
 Crydom International Ltd.
 7 Cobham Road
 Ferndown Industrial Estate
 Wimborne, Dorset BH21 7PE

Germany

Telephone +49 (0) 180 3000 506

ASIA - Thailand

Telephone +66 (0)2 665 2517
 Fax +66 (0)2 665 2588
 Crydom Asia
 18/8 Fico Place 12th Floor
 Soi Sukhumvit 21 (Asoke)
 Klongtoey Nua, Wattana
 Bangkok, Thailand 10110