



Very Low Power/Voltage CMOS SRAM **BS62LV2007** 256K X 8 bit

■ FEATURES

- Wide Vcc operation voltage : 2.4V ~ 5.5V
- Very low power consumption :
 - Vcc = 3.0V C-grade : 20mA (Max.) operating current
I-grade : 25mA (Max.) operating current
0.1uA (Typ.) CMOS standby current
 - Vcc = 5.0V C-grade : 35mA (Max.) operating current
I-grade : 40mA (Max.) operating current
0.6uA (Typ.) CMOS standby current
- High speed access time :
 - 70 70ns(Max.) at Vcc = 3.0V
 - 10 100ns(Max.) at Vcc = 3.0V
- Automatic power down when chip is deselected
- Three state outputs and TTL compatible
- Fully static operation
- Data retention supply voltage as low as 1.5V
- Easy expansion with CE2, CE1, and OE options

■ DESCRIPTION

The BS62LV2007 is a high performance, very low power CMOS Static Random Access Memory organized as 262,144 words by 8 bits and operates in a wide range of 2.4V to 5.5V supply voltage. Advanced CMOS technology and circuit techniques provide both high speed and low power features with a typical CMOS standby current of 0.1uA and maximum access time of 70ns in 3V operation. Easy memory expansion is provided by an active LOW chip enable (CE1), an active HIGH chip enable (CE2), and active LOW output enable (OE) and three-state output drivers. The BS62LV2007 has an automatic power down feature, reducing the power consumption significantly when chip is deselected. The BS62LV2007 is available in the JEDEC standard 36 pin Mini BGA 6x8 mm.

■ PRODUCT FAMILY

PRODUCT FAMILY	OPERATING TEMPERATURE	Vcc RANGE	SPEED (ns)	POWER DISSIPATION				PKG TYPE
				STANDBY (ICCSB1, Max)		Operating (Icc, Max)		
				Vcc= 3.0V	Vcc= 5.0V	Vcc= 3.0V	Vcc= 5.0V	
BS62LV2007HC	0 °C to +70 °C	2.4V ~5.5V	70/100	6 uA	0.7 uA	35 mA	20 mA	BGA-36-0608
BS62LV2007HI	-40 °C to +85 °C		70/100	25 uA	1.5 uA	40 mA	25 mA	

■ PIN CONFIGURATIONS

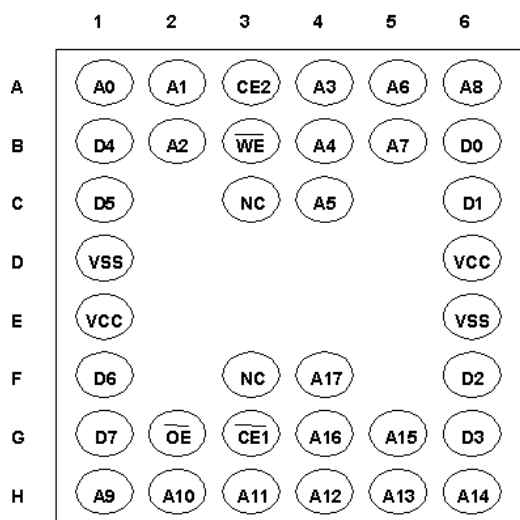

36 Ball Mini BGA (CSP) - Top View

■ BLOCK DIAGRAM

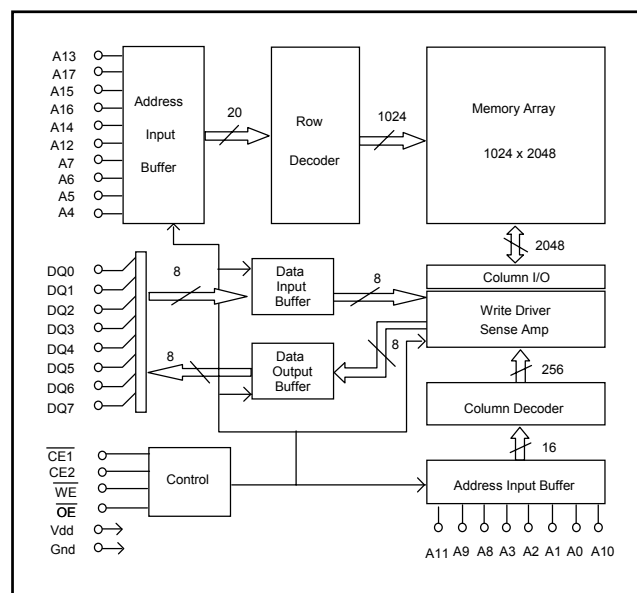

Brilliance Semiconductor Inc. reserves the right to modify document contents without notice.

■ PIN DESCRIPTIONS

Name	Function
A0-A17 Address Input	These 18 address inputs select one of the 262,144 x 8-bit words in the RAM
$\overline{CE1}$ Chip Enable 1 Input CE2 Chip Enable 2 Input	$\overline{CE1}$ is active LOW and CE2 is active HIGH. Both chip enables must be active when data read from or write to the device. If either chip enable is not active, the device is deselected and is in a standby power mode. The DQ pins will be in the high impedance state when the device is deselected.
\overline{WE} Write Enable Input	The write enable input is active LOW and controls read and write operations. With the chip selected, when \overline{WE} is HIGH and \overline{OE} is LOW, output data will be present on the DQ pins; when \overline{WE} is LOW, the data present on the DQ pins will be written into the selected memory location.
\overline{OE} Output Enable Input	The output enable input is active LOW. If the output enable is active while the chip is selected and the write enable is inactive, data will be present on the DQ pins and they will be enabled. The DQ pins will be in the high impedance state when \overline{OE} is inactive.
DQ0 – DQ7 Data Input/Output Ports	These 8 bi-directional ports are used to read data from or write data into the RAM.
Vcc	Power Supply
Gnd	Ground

■ TRUTH TABLE

MODE	\overline{WE}	$\overline{CE1}$	CE2	\overline{OE}	I/O OPERATION	Vcc CURRENT
Not selected (Power Down)	X	H	X	X	High Z	I_{CCSB}, I_{CCSB1}
	X	X	L	X		
Output Disabled	H	L	H	H	High Z	I_{CC}
Read	H	L	H	L	DOUT	I_{CC}
Write	L	L	H	X	DIN	I_{CC}

■ ABSOLUTE MAXIMUM RATINGS⁽¹⁾

SYMBOL	PARAMETER	RATING	UNITS
V TERM	Terminal Voltage with Respect to GND	-0.5 to Vcc+0.5	V
T BIAS	Temperature Under Bias	-40 to +125	°C
T STG	Storage Temperature	-60 to +150	°C
P T	Power Dissipation	1.0	W
I OUT	DC Output Current	20	mA

1. Stresses greater than those listed under ABSOLUTE MAXIMUM RATINGS may cause permanent damage to the device. This is a stress rating only and functional operation of the device at these or any other conditions above those indicated in the operational sections of this specification is not implied. Exposure to absolute maximum rating conditions for extended periods may affect reliability.

■ OPERATING RANGE

RANGE	AMBIENT TEMPERATURE	Vcc
Commercial	0 °C to +70 °C	2.4V ~ 5.5V
Industrial	-40 °C to +85 °C	2.4V ~ 5.5V

■ CAPACITANCE ⁽¹⁾ (TA = 25°C, f = 1.0 MHz)

SYMBOL	PARAMETER	CONDITIONS	MAX.	UNIT
CIN	Input Capacitance	VIN=0V	6	pF
CDQ	Input/Output Capacitance	VI/O=0V	8	pF

1. This parameter is guaranteed and not tested.

DC ELECTRICAL CHARACTERISTICS (TA = 0°C to + 70°C)

PARAMETER NAME	PARAMETER	TEST CONDITIONS	MIN.	TYP. ⁽¹⁾	MAX.	UNITS	
V _{IL}	Guaranteed Input Low Voltage ⁽²⁾	V _{CC} = 3.0V V _{CC} = 5.0V	-0.5	--	0.8	V	
V _{IH}	Guaranteed Input High Voltage ⁽²⁾		V _{CC} = 3.0V V _{CC} = 5.0V	2.0 2.2	--	V _{CC} +0.2	V
I _{IL}	Input Leakage Current	V _{CC} = Max, V _{IN} = 0V to V _{CC}	--	--	1	uA	
I _{OL}	Output Leakage Current	V _{CC} = Max, $\overline{CE1} = V_{IH}$, CE2 = V _{IL} , or $\overline{OE} = V_{IH}$, V _{IO} = 0V to V _{CC}	--	--	1	uA	
V _{OL}	Output Low Voltage	V _{CC} = Max, I _{OL} = 2mA	--	--	0.4	V	
V _{OH}	Output High Voltage	V _{CC} = Min, I _{OH} = -1mA					
I _{CC}	Operating Power Supply Current	$\overline{CE1} = V_{IL}$, or CE2 = V _{IH} , I _{DQ} = 0mA, F = F _{max} ⁽³⁾	V _{CC} = 3.0V V _{CC} = 5.0V	-- --	20 35	mA	
I _{CCSB}	Standby Current-TTL	$\overline{CE1} = V_{IH}$, or CE2 = V _{IL} , I _{DQ} = 0mA, F = F _{max} ⁽³⁾	V _{CC} = 3.0V V _{CC} = 5.0V	-- --	1 2	mA	
I _{CCSB1}	Standby Current-CMOS	$\overline{CE1} \geq V_{CC} - 0.2V$, CE2 $\leq 0.2V$, V _{IN} $\geq V_{CC} - 0.2V$ or V _{IN} $\leq 0.2V$	V _{CC} = 3.0V V _{CC} = 5.0V	-- --	0.1 0.6	0.7 6	uA

1. Typical characteristics are at TA = 25°C.

2. These are absolute values with respect to device ground and all overshoots due to system or tester noise are included.

3. F_{max} = 1/t_{RC}.

DATA RETENTION CHARACTERISTICS (TA = 0°C to + 70°C)

SYMBOL	PARAMETER	TEST CONDITIONS	MIN.	TYP. ⁽¹⁾	MAX.	UNITS
V _{DR}	V _{CC} for Data Retention	$\overline{CE1} \geq V_{CC} - 0.2V$, CE2 $\leq 0.2V$, V _{IN} $\geq V_{CC} - 0.2V$ or V _{IN} $\leq 0.2V$	1.5	--	--	V
I _{CCDR}	Data Retention Current	$\overline{CE1} \geq V_{CC} - 0.2V$, CE2 $\leq 0.2V$, V _{IN} $\geq V_{CC} - 0.2V$ or V _{IN} $\leq 0.2V$	--	0.01	0.5	uA
t _{CDR}	Chip Deselect to Data Retention Time	See Retention Waveform	0	--	--	ns
t _R	Operation Recovery Time		T _{RC} ⁽²⁾	--	--	ns

1. V_{CC} = 1.5V, T_A = + 25°C

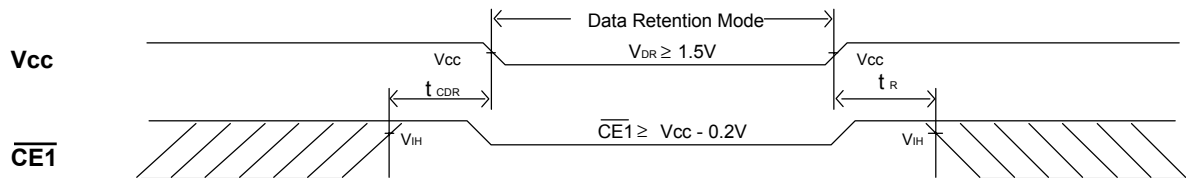
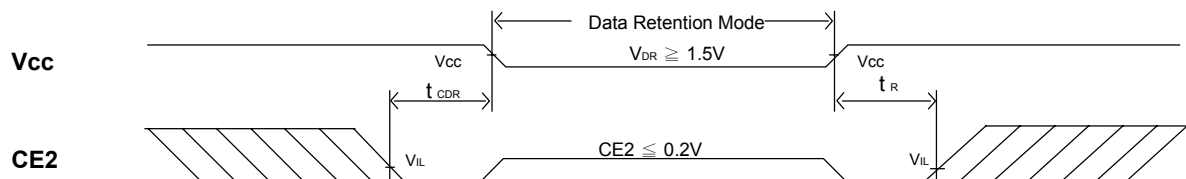

2. t_{RC} = Read Cycle Time

LOW V_{CC} DATA RETENTION WAVEFORM (1) ($\overline{CE1}$ Controlled)

LOW V_{CC} DATA RETENTION WAVEFORM (2) (CE2 Controlled)

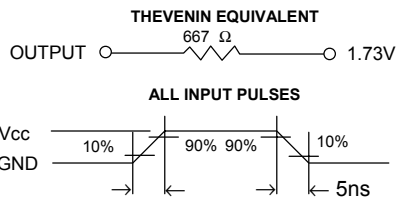
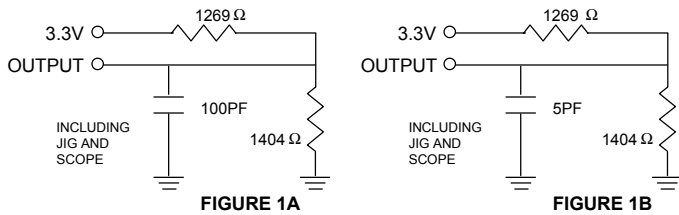
■ AC TEST CONDITIONS

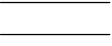
Input Pulse Levels	V _{cc} /0V
Input Rise and Fall Times	5ns
Input and Output Timing Reference Level	0.5V _{cc}

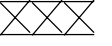
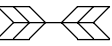
■ AC TEST LOADS AND WAVEFORMS

FIGURE 2
■ KEY TO SWITCHING WAVEFORMS

WAVEFORM	INPUTS	OUTPUTS
	MUST BE STEADY	MUST BE STEADY
	MAY CHANGE FROM H TO L	WILL BE CHANGE FROM H TO L
	MAY CHANGE FROM L TO H	WILL BE CHANGE FROM L TO H
	DON'T CARE: ANY CHANGE PERMITTED	CHANGE: STATE UNKNOWN
	DOES NOT APPLY	CENTER LINE IS HIGH IMPEDANCE "OFF" STATE

■ AC ELECTRICAL CHARACTERISTICS (TA = 0°C to +70°C, V_{cc} = 3.0V)
READ CYCLE

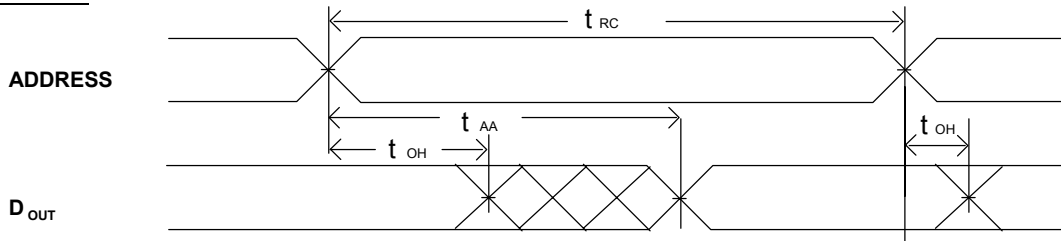
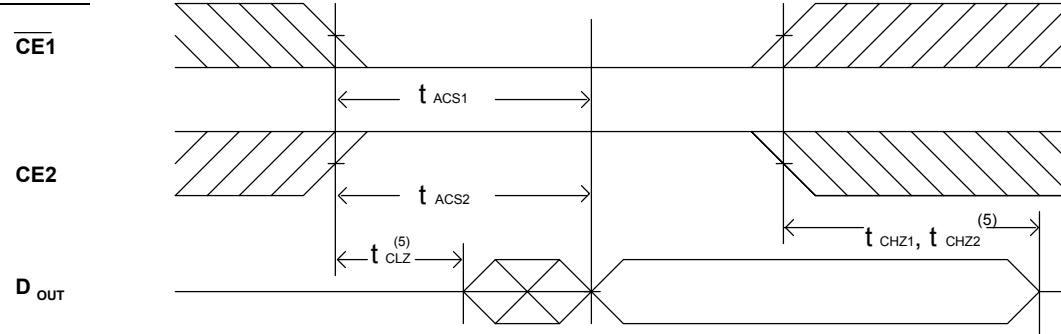
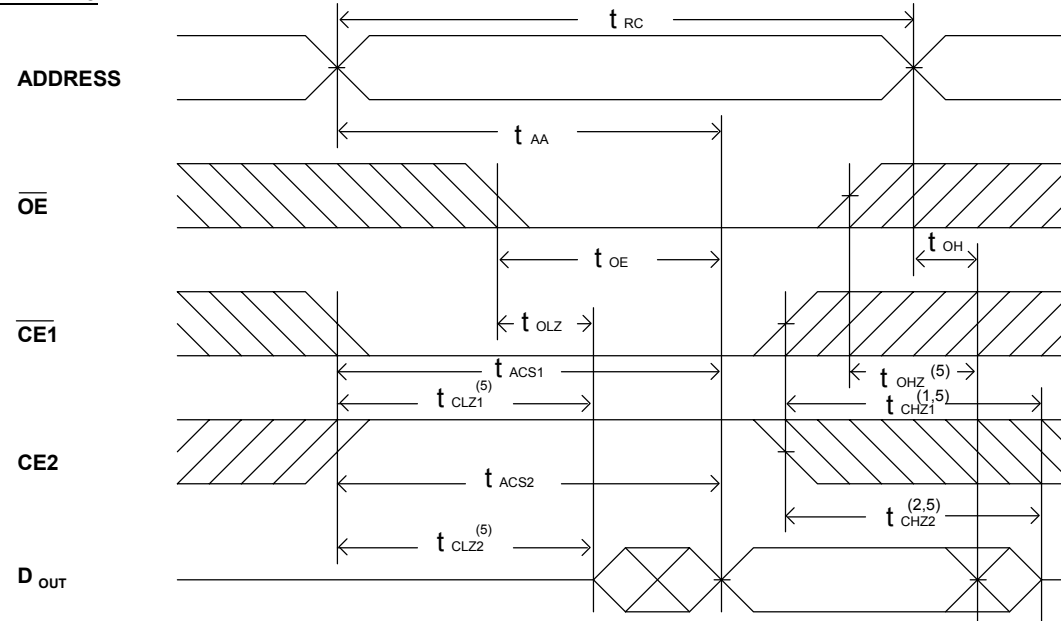
JEDEC PARAMETER NAME	PARAMETER NAME	DESCRIPTION	BS62LV2007-70			BS62LV2007-10			UNIT
			MIN.	TYP.	MAX.	MIN.	TYP.	MAX.	
t _{AVAX}	t _{RC}	Read Cycle Time	70	--	--	100	--	--	ns
t _{AVQV}	t _{AA}	Address Access Time	--	--	70	--	--	100	ns
t _{E1LQV}	t _{ACS1}	Chip Select Access Time (CE1)	--	--	70	--	--	100	ns
t _{E2HOV}	t _{ACS2}	Chip Select Access Time (CE2)	--	--	70	--	--	100	ns
t _{GLQV}	t _{OE}	Output Enable to Output Valid	--	--	35	--	--	50	ns
t _{E1LQX}	t _{CLZ1}	Chip Select to Output Low Z (CE1)	10	--	--	15	--	--	ns
t _{E2HOX}	t _{CLZ2}	Chip Select to Output Low Z (CE2)	10	--	--	15	--	--	ns
t _{GLQX}	t _{OLZ}	Output Enable to Output in Low Z	10	--	--	15	--	--	ns
t _{E1HQZ}	t _{CHZ1}	Chip Deselect to Output in High Z (CE1)	0	--	35	0	--	40	ns
t _{E2HQZ}	t _{CHZ1}	Chip Deselect to Output in High Z (CE2)	0	--	35	0	--	40	ns
t _{GHQZ}	t _{OHZ}	Output Disable to Output in High Z	0	--	30	0	--	35	ns
t _{AXOX}	t _{OH}	Output Disable to Output Address Change	10	--	--	15	--	--	ns

SWITCHING WAVEFORMS (READ CYCLE)
READ CYCLE1 (1,2,4)

READ CYCLE2 (1,3,4)

READ CYCLE3 (1,4)

NOTES:

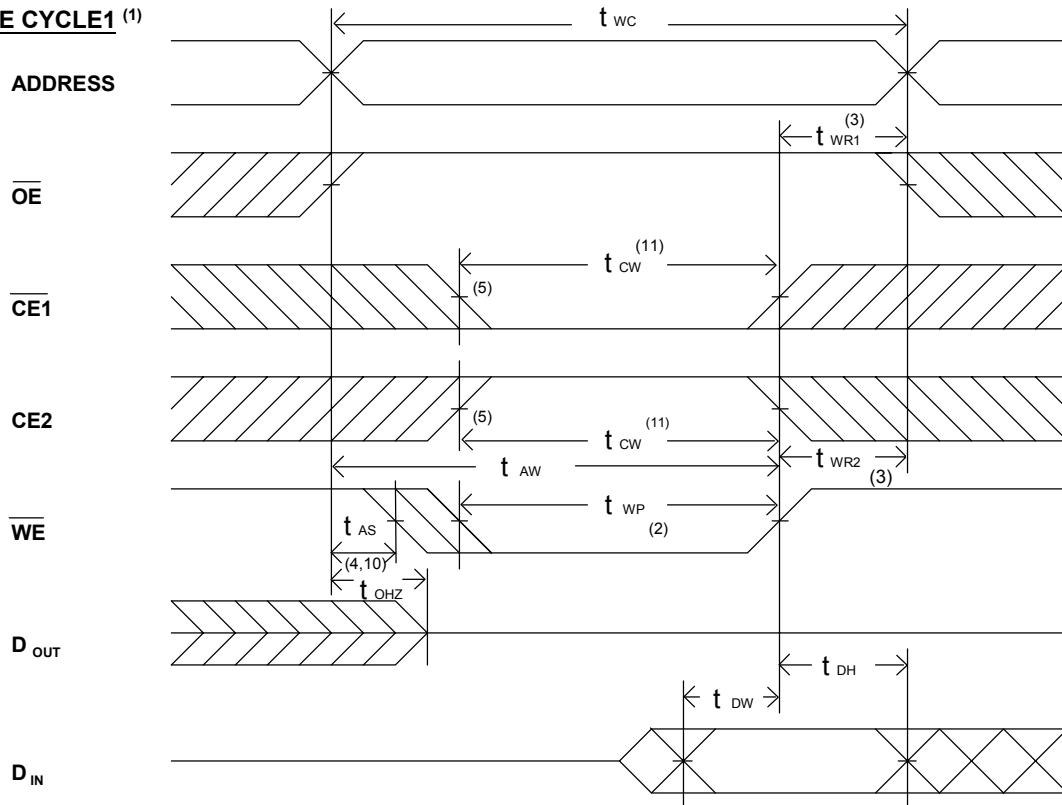
1. WE is high for read Cycle.
2. Device is continuously selected when $\overline{CE1} = V_{IL}$ and $CE2 = V_{IH}$.
3. Address valid prior to or coincident with $\overline{CE1}$ transition low and/or $CE2$ transition high.
4. $\overline{OE} = V_{IL}$.
5. Transition is measured $\pm 500mV$ from steady state with $C_L = 5pF$ as shown in Figure 1B. The parameter is guaranteed but not 100% tested.

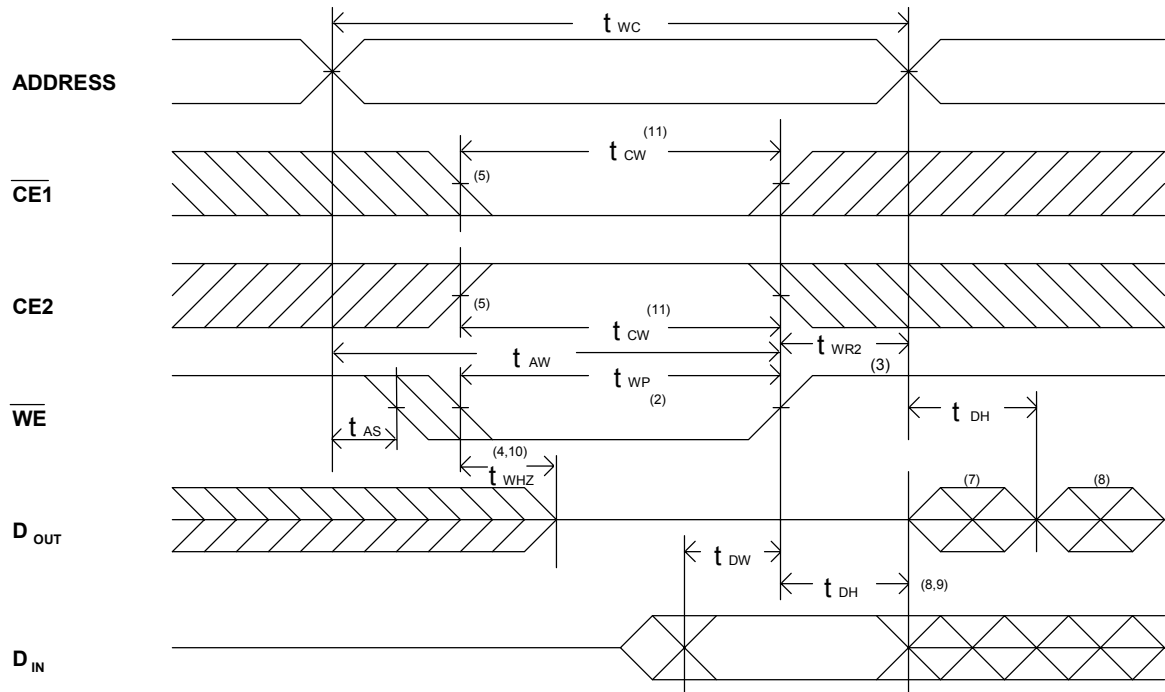
■ AC ELECTRICAL CHARACTERISTICS (TA = 0°C to + 70°C, Vcc = 3.0V)
WRITE CYCLE

JEDEC PARAMETER NAME	PARAMETER NAME	DESCRIPTION	BS62LV2007-70			BS62LV2007-10			UNIT
			MIN.	TYP.	MAX.	MIN.	TYP.	MAX.	
t_{AVAX}	t_{WC}	Write Cycle Time	70	--	--	100	--	--	ns
t_{E1LWH}	t_{CW}	Chip Select to End of Write	70	--	--	100	--	--	ns
t_{AVWL}	t_{AS}	Address Set up Time	0	--	--	0	--	--	ns
t_{AWWH}	t_{AW}	Address Valid to End of Write	70	--	--	100	--	--	ns
t_{WLWH}	t_{WP}	Write Pulse Width	35	--	--	50	--	--	ns
t_{WHAX}	t_{WR1}	Write Recovery Time ($\overline{CE1}$, \overline{WE})	0	--	--	0	--	--	ns
t_{E2LAX}	t_{WR2}	Write Recovery Time (CE2)	0	--	--	0	--	--	ns
t_{WLOZ}	t_{WHZ}	Write to Output in High Z	0	--	30	0	--	40	ns
t_{DVWH}	t_{DW}	Data to Write Time Overlap	30	--	--	40	--	--	ns
t_{WHDX}	t_{DH}	Data Hold from Write Time	0	--	--	0	--	--	ns
t_{GHOZ}	t_{OHZ}	Output Disable to Output in High Z	0	--	30	0	--	40	ns
t_{WHQX}	t_{OW}	End of Write to Output Active	5	--	--	10	--	--	ns

■ SWITCHING WAVEFORMS (WRITE CYCLE)
WRITE CYCLE1⁽¹⁾

WRITE CYCLE2 (1,6)

NOTES:

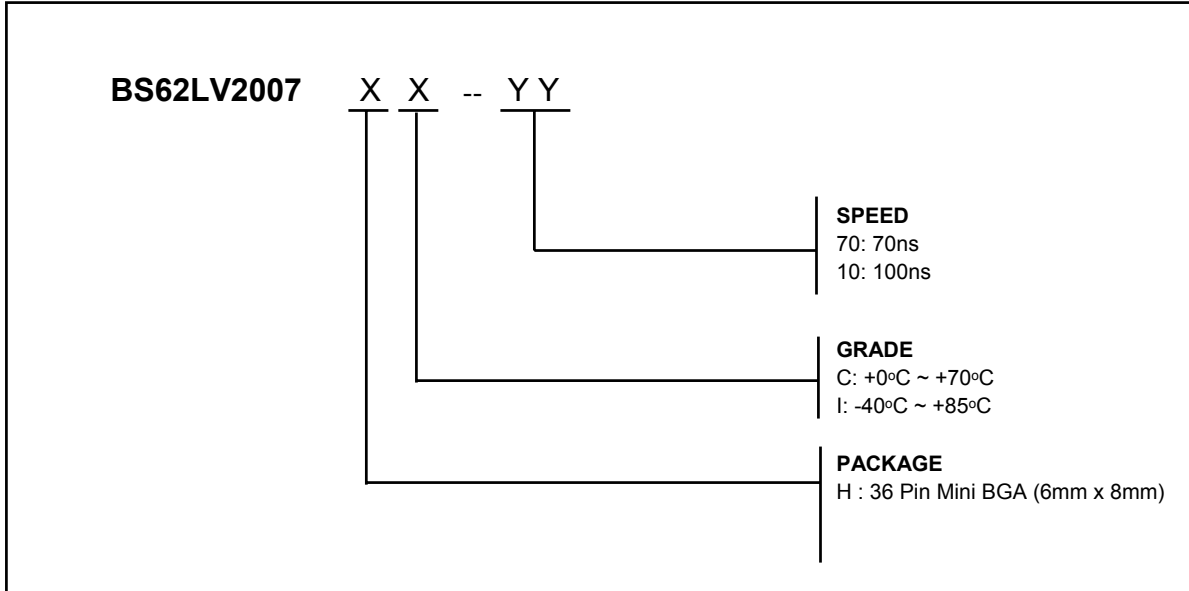
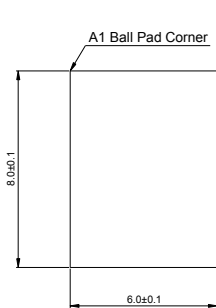
1. \overline{WE} must be high during address transitions.
2. The internal write time of the memory is defined by the overlap of $\overline{CE1}$ and CE2 active and \overline{WE} low. All signals must be active to initiate a write and any one signal can terminate a write by going inactive. The data input setup and hold timing should be referenced to the second transition edge of the signal that terminates the write.
3. t_{WR} is measured from the earlier of $\overline{CE1}$ or \overline{WE} going high or CE2 going low at the end of write cycle.
4. During this period, DQ pins are in the output state so that the input signals of opposite phase to the outputs must not be applied.
5. If the $\overline{CE1}$ low transition or the CE2 high transition occurs simultaneously with the \overline{WE} low transitions or after the \overline{WE} transition, output remain in a high impedance state.
6. \overline{OE} is continuously low ($\overline{OE} = V_{IL}$).
7. D_{OUT} is the same phase of write data of this write cycle.
8. D_{OUT} is the read data of next address.
9. If $\overline{CE1}$ is low and CE2 is high during this period, DQ pins are in the output state. Then the data input signals of opposite phase to the outputs must not be applied to them.
10. Transition is measured $\pm 500mV$ from steady state with $C_L = 5pF$ as shown in Figure 1B. The parameter is guaranteed but not 100% tested.
11. t_{CW} is measured from the later of $\overline{CE1}$ going low or CE2 going high to the end of write.

ORDERING INFORMATION

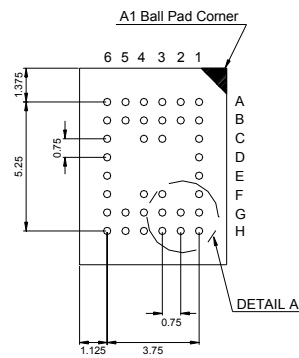
PACKAGE DIMENSIONS

TOP VIEW

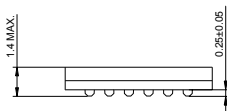
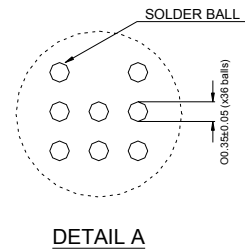

BOTTOM VIEW (BALL SIDE)



SIDE VIEW

NOTE:

1. PIN#1 DOT MARKING IS BY LASER OR PAD PRINT.

36 mini-BGA (6 x 8)

REVISION HISTORY

Revision	Description	Date	Note
1.0	Data Sheet release	Jan. 10, 2002	
2.0	Modify some AC parameters. Modify 5V ICCSB1_Max(I-grade) from 10uA to 25uA.	April,12,2002	