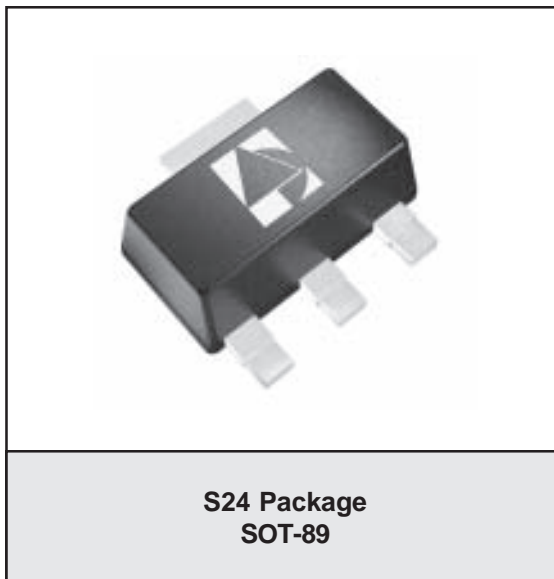


**FEATURES**

- 50 to 1000 MHz Frequency Range
- Input IP3: +24 dBm
- Noise Figure: 2.3 dB
- Single +5 V Supply
- Small SOT-89 Package

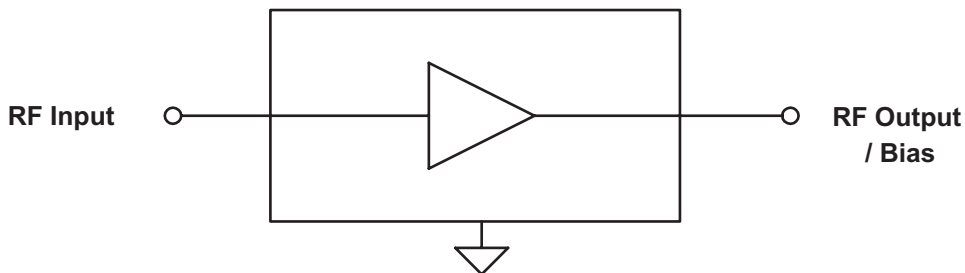
**APPLICATIONS**

- Low Noise Amplifier for CATV Set-Top Boxes
- CATV Drop Amplifier

**PRODUCT DESCRIPTION**

The ADA1200 is a highly linear amplifier developed to meet the stringent requirements of CATV systems. Offered in a low cost SOT-89 package, this GaAs MESFET design offers low noise and low distortion over a wide range of frequencies. The device is ideally

suited for applications as a Low Noise Amplifier in CATV Set-Top Boxes, and as a Drop Amplifier in CATV distribution systems. The ADA1200 requires a single +5 V supply, and typically consumes 400 mW of power.



**Figure 1: Block Diagram**

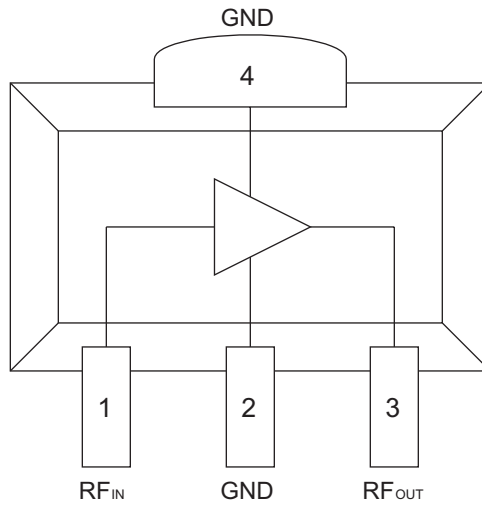


Figure 2: Pinout

Table 1: Pin Description

PIN	NAME	DESCRIPTION
1	RF <sub>IN</sub>	RF Input
2	GND	Ground
3	RF <sub>OUT</sub>	RF Output / Bias
4	GND	Ground

## ELECTRICAL CHARACTERISTICS

Table 2: Absolute Minimum and Maximum Ratings

PARAMETER	MIN	MAX	UNIT
Device Voltage ( $V_{CC}$ )	0	+9	VDC
RF Input Power ( $P_{IN}$ )	-	+10	dBm
Storage Temperature ( $T_{STG}$ )	-40	+150	°C
Junction Temperature	-	TBD	°C

Stresses in excess of the absolute ratings may cause permanent damage. Functional operation is not implied under these conditions. Exposure to absolute ratings for extended periods of time may adversely affect reliability.

Table 3: Operating Ranges

PARAMETER	MIN	TYP	MAX	UNIT
RF Input/Output Frequency	50	-	1000	MHz
Supply Voltage ( $V_{DD}$ )	-	+5	-	VDC
Case Temperature ( $T_C$ )	-40	-	+100	°C

The device may be operated safely over these conditions; however, parametric performance is guaranteed only over the conditions defined in the electrical specifications.

**Table 4: Electrical Specifications**  
 (T<sub>A</sub> = +25 °C, V<sub>DD</sub> = +5 VDC, 75 Ω system)

PARAMETER	MIN	TYP	MAX	UNIT
Gain	-	12	-	dB
CTB <sup>(1)</sup>	-	-75	-	dBc
CSO <sup>(1)</sup>	-	-63	-	dBc
XMOD <sup>(1)</sup>	-	-73	-	dBc
3rd Order Input Intercept Point (IIP3) <sup>(2)</sup>	-	+24	-	dBm
2rd Order Input Intercept Point (IIP2) <sup>(3)</sup>	-	+46	-	dBm
Noise Figure	-	2.3	-	dB
Input Return Loss	-	-25	-	dB
Output Return Loss	-	-25	-	dB
Thermal Resistance (θ <sub>JC</sub> )	-	-	50	°C/W
Supply Current	-	80	-	mA

Notes:

(1) 132 channels, +15 dBmV per channel (measured at input), 6 MHz channel spacing.

(2) Two tones, -10 dBm per tone at input, 1 MHz spacing.

(3) Two tones, at 425 MHz and 475 MHz, -10 dBm input per tone.

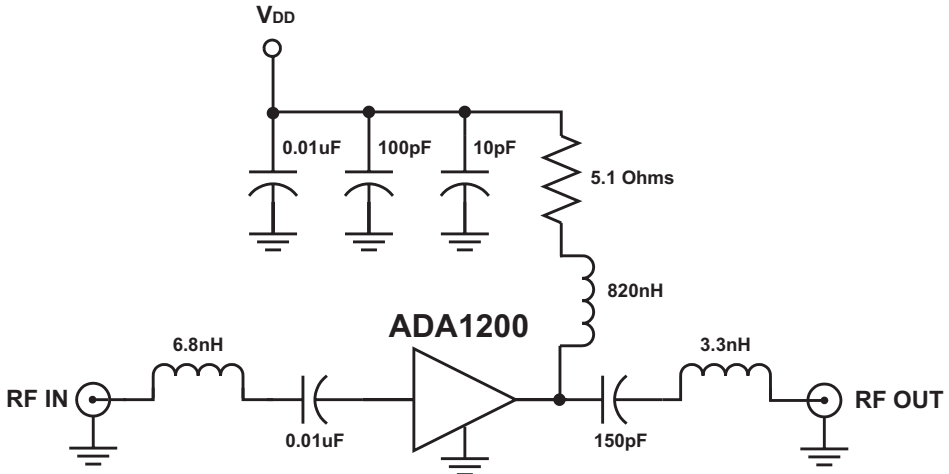
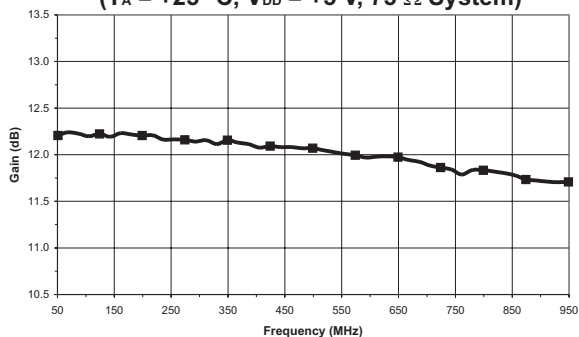


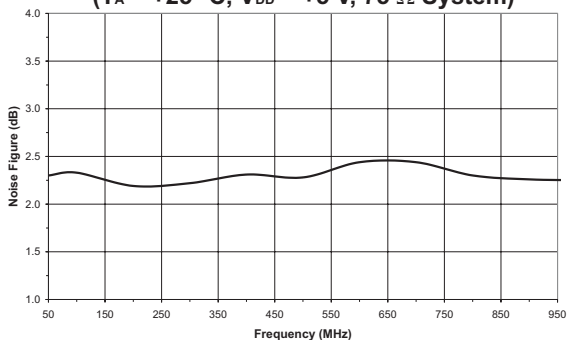
Figure 3: Test Circuit

PERFORMANCE DATA

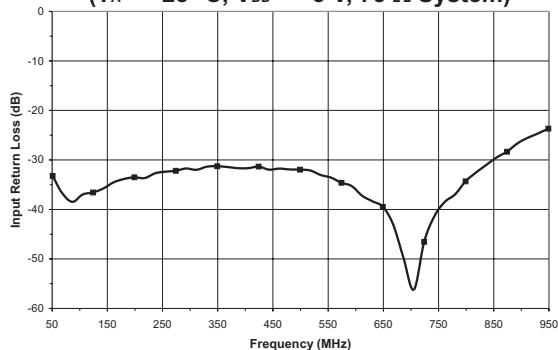
**Figure 4: Gain vs. Frequency**  
 (T<sub>A</sub> = +25 °C, V<sub>DD</sub> = +5 V, 75 Ω System)



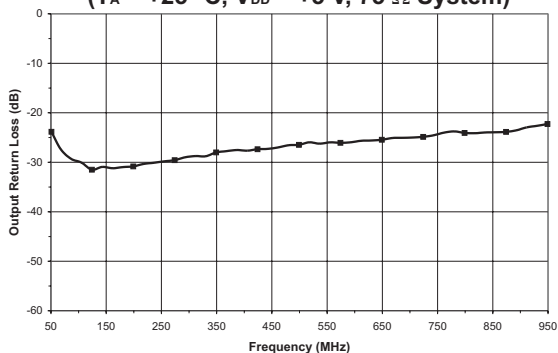
**Figure 5: Noise Figure vs. Frequency**  
 (T<sub>A</sub> = +25 °C, V<sub>DD</sub> = +5 V, 75 Ω System)



**Figure 6: Input Return Loss vs. Frequency**  
 (T<sub>A</sub> = +25 °C, V<sub>DD</sub> = +5 V, 75 Ω System)

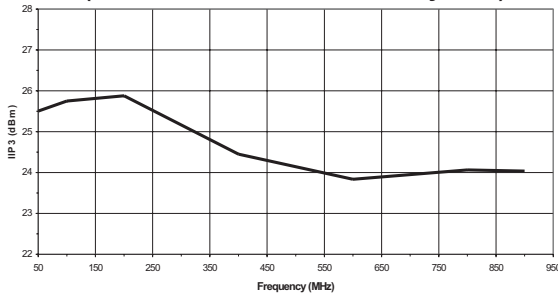


**Figure 7: Output Return Loss vs. Frequency**  
 (T<sub>A</sub> = +25 °C, V<sub>DD</sub> = +5 V, 75 Ω System)

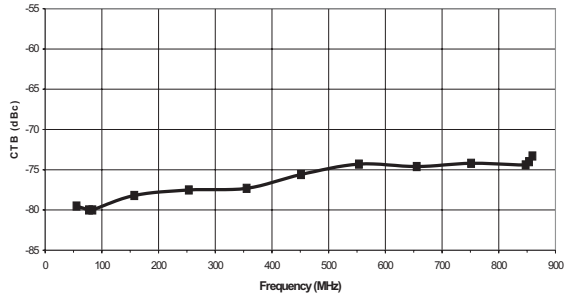


S-parameter data for the unmatched device are available upon request, and on the ANADIGICS web site.

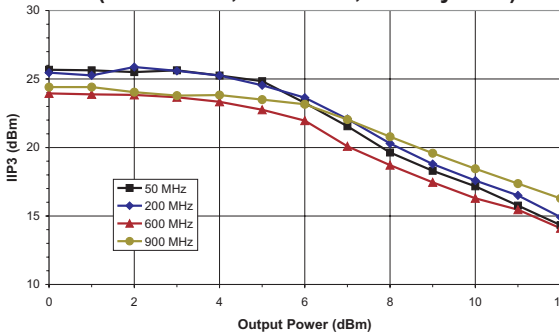
**Figure 8: Input IP3 vs. Frequency**  
 (T<sub>A</sub> = +25 °C, V<sub>DD</sub> = +5 V, 75 Ω System)



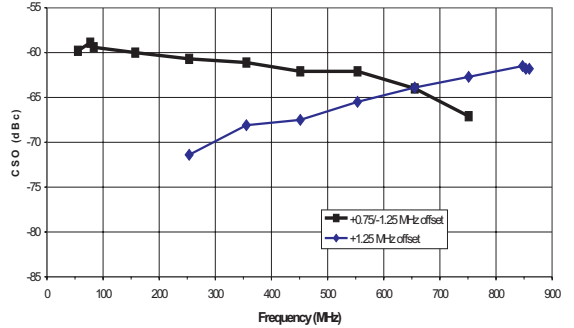
**Figure 9: CTB vs. Frequency**  
 (T<sub>A</sub> = +25 °C, V<sub>DD</sub> = +5 V, 132 channels,  
 +15 dBmV input power per channel)



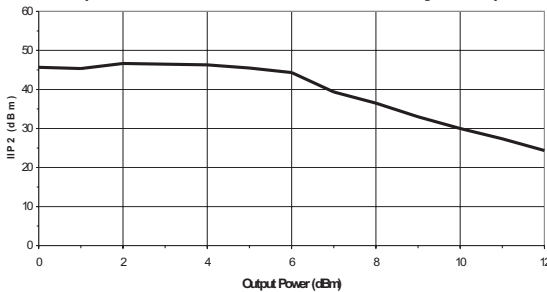
**Figure 10: Input IP3 vs. Output Power**  
 (T<sub>A</sub> = +25 °C, V<sub>DD</sub> = +5 V, 75 Ω system)



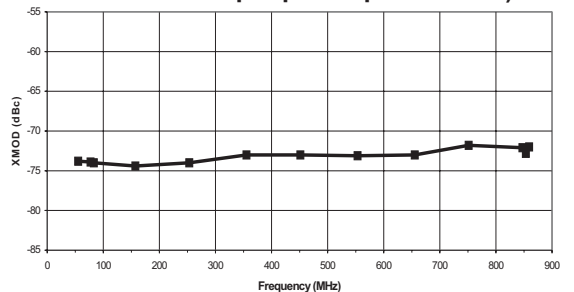
**Figure 11: CSO vs. Frequency**  
 (T<sub>A</sub> = +25 °C, V<sub>DD</sub> = +5 V, 132 channels,  
 +15 dBmV input power per channel)



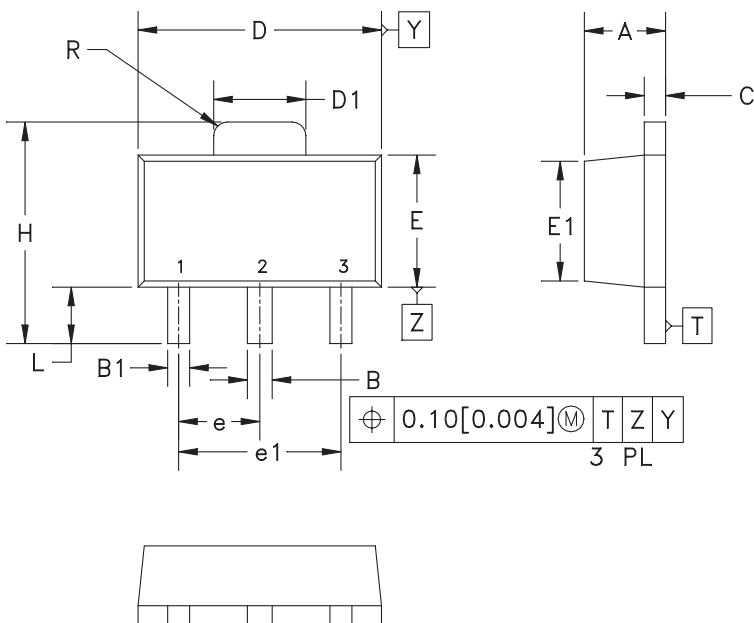
**Figure 12: Input IP2 vs. Output Power**  
 (T<sub>A</sub> = +25 °C, V<sub>DD</sub> = +5 V, 75 Ω system)



**Figure 13: XMOD vs. Frequency**  
 (T<sub>A</sub> = +25 °C, V<sub>DD</sub> = +5 V, 132 channels,  
 +15 dBmV input power per channel)



PACKAGE OUTLINE



S <sub>MPO</sub>	MILLIMETERS		INCHES		NOTE
	MIN.	MAX.	MIN.	MAX.	
A	1.40	1.60	0.055	0.063	—
B	0.44	0.56	0.017	0.022	—
B1	0.36	0.48	0.014	0.019	3
C	0.35	0.44	0.014	0.017	—
D	4.40	4.60	0.173	0.181	—
D1	1.62	1.83	0.064	0.072	—
E	2.29	2.60	0.090	0.102	—
E1	2.13	2.29	0.084	0.090	4
e	1.50 BSC		0.059 BSC		—
e1	3.00 BSC		0.118 BSC		—
H	3.94	4.25	0.155	0.167	—
L	0.89	1.20	0.035	0.047	—
R	—	0.25	—	0.010	—

NOTES:

1. CONTROLLING DIMENSIONS: MILLIMETERS.
2. DIMENSIONS DO NOT INCLUDE END FLASH, MOLD FLASH OR MATERIAL PROTRUSIONS.
3. DIMENSION B1, 2 PLACES.
4. DIMENSION E1 – REFERENCE ONLY.
5. REFERENCE JEDEC TO-243 (AA).

Figure 14: S24 Package Outline – SOT-89

TOP BRAND



NOTES:

1. ANADIGICS LOGO SIZE: X=0.040±0.010 Y=0.048±0.010
2. PART NUMBER: FOUR NUMERIC CHARACTERS
3. WAFER LOT NUMBER: LLLL= FOUR NUMERIC CHARACTERS  
NN= TWO ALPHABETIC CHARACTERS
4. TYPE : ELITE  
SIZE : 2-POINT  
COLOR : LASER

Figure 15: Branding Specification

**ORDERING INFORMATION**

PART NUMBER	TEMPERATURE RANGE	PACKAGE DESCRIPTION	COMPONENT PACKAGING
ADA1200S24Q1	-40 to +100°C	SOT-89 Package	1,000 piece Tape and Reel

**ANADIGICS, Inc.**

141 Mount Bethel Road  
 Warren, New Jersey 07059, U.S.A.  
 Tel: +1 (908) 668-5000  
 Fax: +1 (908) 668-5132

URL: <http://www.anadigics.com>  
 E-mail: [Mktg@anadigics.com](mailto:Mktg@anadigics.com)

**IMPORTANT NOTICE**

ANADIGICS, Inc. reserves the right to make changes to its products or to discontinue any product at any time without notice. The product specifications contained in Advanced Product Information sheets and Preliminary Data Sheets are subject to change prior to a product's formal introduction. Information in Data Sheets have been carefully checked and are assumed to be reliable; however, ANADIGICS assumes no responsibilities for inaccuracies. ANADIGICS strongly urges customers to verify that the information they are using is current before placing orders.

**WARNING**

ANADIGICS products are not intended for use in life support appliances, devices or systems. Use of an ANADIGICS product in any such application without written consent is prohibited.