

DC – 6 GHz Unterminated SPDT Switch

Technical Data

HMMC-2006

Features

- **Frequency Range:** DC-6 GHz
- **Insertion Loss:**
< 1dB @ 6 GHz
- **Isolation:**
> 70 dB @ 45 MHz
> 35 dB @ 6 GHz
- **Return Loss:** > 12 dB
(Both Input & Output)
- **Switching Speed:** < 1 ns
- **P_{-1dB}:**
23 dBm @ 50 MHz
> 27dBm @ 6 GHz
- **Harmonics:** < -25 dBc @
20 dBm (DC coupled)

Description

The HMMC-2006 is a GaAs monolithic microwave integrated circuit (MMIC) designed for low insertion loss and high isolation from DC to 6 GHz. It is intended for use as a general-purpose, singlepole, double-throw (SPDT) switch. One series and two shunt MESFETs per throw provide 1.2 dB maximum insertion loss and 35 dB minimum isolation at 6 GHz. HMMC-2006 chips use through-substrate vias to provide ground connections to the chip backside and minimize the number of wire bonds required. The HMMC-2006 is also available in an 8-lead flatpack (1GG7-4201).

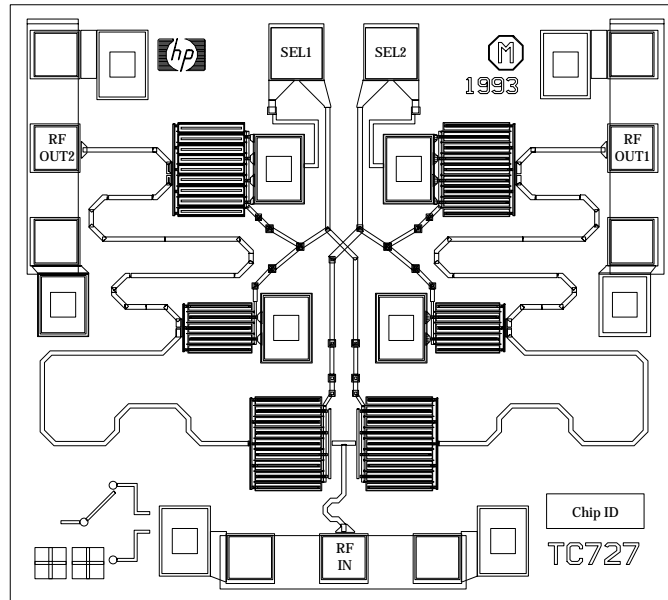

Chip Size:	960 x 1070 μm (37.8 x 42.1 mils)
Chip Size Tolerance:	+0, -10 μm (+0, -0.4 mils)
Chip Thickness:	127 \pm 15 μm (5.0 \pm 0.6 mils)
Pad Dimensions:	80 x 80 μm (3.2 x 3.2 mils), or larger

Absolute Maximum Ratings^[1]

Symbol	Parameters/Conditions	Units	Min.	Max.
V _{sel}	Select Voltages 1 and 2	V	-12	+3
P _{in}	RF Input Power	dBm		30
T _{op}	Operating Temperature	°C	-55	+125
T _{STG}	Storage Temperature	°C	-65	+165
T _{max}	Maximum Assembly Temp. (for 60 seconds max.)	°C		+300

Note:

1. Operation in excess of any one of these conditions may result in permanent damage to this device. T_A = 25°C except for T_{ch}, T_{STG}, and T_{max}.

DC Specifications/Physical Properties, $T_A = 25^\circ\text{C}$

Symbol	Parameters and Test Conditions	Units	Min.	Typ.	Max.
I_l	Leakage Current @ -10 V	μA			100
V_p	Pinch-off Voltage @ 8 mA	V	-6.75		-3.25
BV_{gss}	Breakdown Voltage Total	V	-18.0		-12.5

RF Specifications, $T_A = 25^\circ\text{C}$, $Z_O = 50 \Omega$, $V_{sel\ high} = 0\text{ V}$, $V_{sel\ low} = -10\text{ V}$

Symbol	Parameters and Test Conditions	Units	Min.	Typ.	Max.
BW	Guaranteed Operating Bandwidth	GHz	DC		6
IL	Insertion Loss, RF_{in} to RF_{out} , $f = 6\text{ GHz}$, ON throw	dB		1	1.2
ISO	Isolation, RF_{in} to RF_{out} , $f = 6\text{ GHz}$, OFF throw	dB	35	40	
RL_{in}	Input Return Loss	dB	12	14	
RL_{out}	Output Return Loss	dB	12	15	
$P_{1\text{ dB}}$	Input Power where IL increases by 1 dB $f = 50\text{ MHz}$	dBm	18	23	
t_s	Switching Speed, 10%–90% RF Envelope, $f = 2\text{ GHz}$	ns		1	

Applications

The HMMC-2006 can be used in instrumentation, communications, radar, ECM, EW, and many other systems requiring SPDT switching. It can be used for pulse modulation, port isolation, transfer switching, high-speed switching, replacement of mechanical switches, and so on. It can also be used as a terminated SPST (single-pole-single-throw) switch by placing a 50 Ω load on either RF output port.

Assembly Techniques

Die attach may be done with either a AuSn solder preform or conductive epoxy. Gold thermosonic bonding is recommended for all bonds. The top and bottom metallization is gold. For more detailed information see HP application note #999 "GaAs MMIC Assembly and Handling Guidelines."

GaAs MMICs are ESD sensitive. Proper precautions should be used when handling these devices.

S-Parameters^[1], $T_A = 25^\circ\text{C}$, $Z_0 = 50\ \Omega$, $V_{\text{sel high}} = 0\ \text{V}$, $V_{\text{sel low}} = -10\ \text{V}$

Frequency GHz	S_{11}		S_{21} (Insertion Loss)		S_{31} (Isolation)	
	Mag.	Ang.	Mag.	Ang.	Mag.	Ang.
0.1	0.93	-8	4.26	172	0.01	86
0.5	0.0365	-27.03	0.9366	-11.32	0.0010	78.03
1.0	0.0372	-41.81	0.9336	-17.35	0.0017	76.84
1.5	0.0448	-63.14	0.9311	-23.47	0.0026	76.05
2.0	0.0542	-80.60	0.9286	-27.67	0.0033	75.66
2.5	0.0631	-88.46	0.9271	-29.73	0.0039	77.4
3.0	0.0715	-93.98	0.9242	-33.03	0.0049	81.14
3.5	0.0795	-101.90	0.9199	-38.93	0.0059	82.09
4.0	0.0872	-108.90	0.9164	-45.14	0.0063	78.90
4.5	0.0951	-114.40	0.9123	-50.49	0.0068	78.94
5.0	0.1022	-120.90	0.9054	-56.36	0.0078	84.68
5.5	0.1074	-123.50	0.9032	-62.07	0.0084	84.71
6.0	0.1138	-132.70	0.9058	-69.04	0.0115	91.24

Note:

1. 3-port-wafer-probed data.

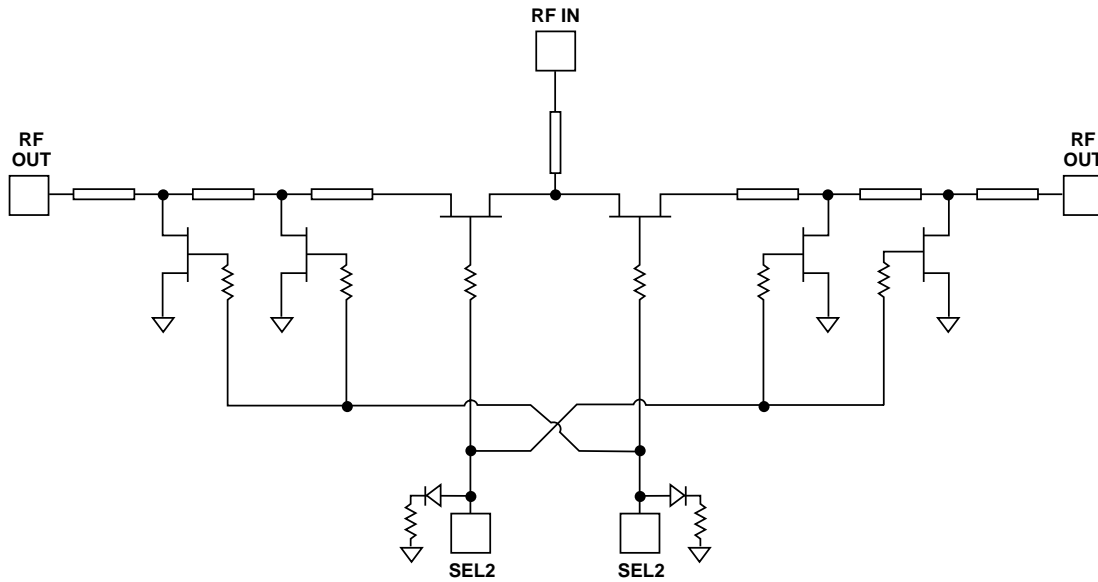

Figure 1. HMMC-2006 Schematic.

Recommended Operating Conditions, $T_A = 25^\circ\text{C}$

Select Line		RF Path	
SEL1	SEL2	RF IN to RF OUT1	RF IN to RF OUT2
-10V	0V	Isolated	Low Loss
0V	-10V	Low Loss	Isolated

HMMC-2006 Typical Performance

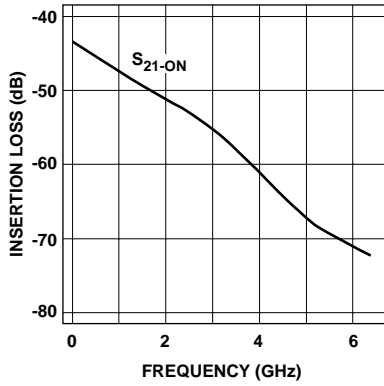

Figure 2. Insertion Loss^[1] vs. Frequency.

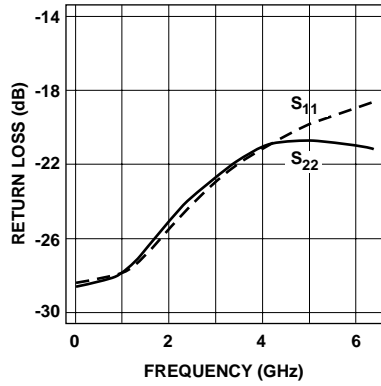

Figure 3. Input and Output (On Throw) Return Loss^[1] vs. Frequency.

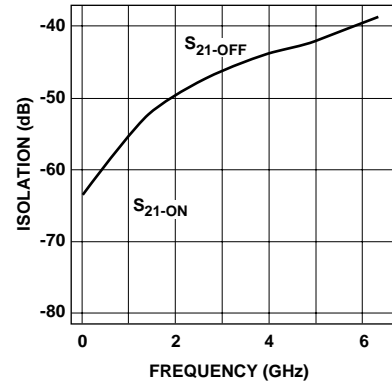

Figure 4. Input-to-Output Isolation^[1] vs. Frequency.

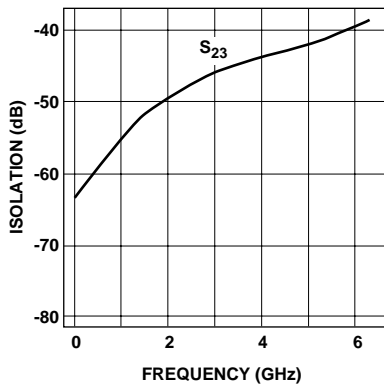

Figure 5. Output-to-Output Isolation^[2] vs. Frequency.

Notes:

1. Wafer-probed measurements
2. Calculated from wafer-probed measurements

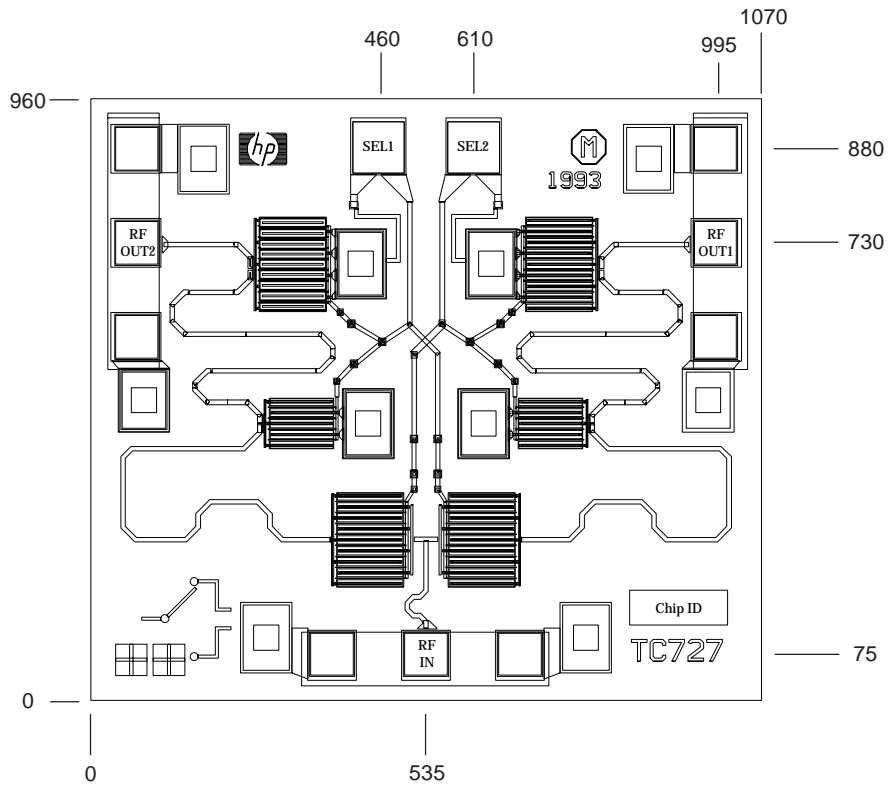

Figure 6. HMMC-2006 Bonding Pad Locations. (Dimensions in micrometers)

This data sheet contains a variety of typical and guaranteed performance data. The information supplied should not be interpreted as a complete list of circuit specifications. In this data sheet the term *typical* refers to the 50th percentile performance. For additional information contact your local HP sales representative.