

# Low Profile T-1 (3 mm) LED Lamps

## Technical Data

**HLMP-1350**  
**HLMP-1450**  
**HLMP-1550**

### Features

- **Low Profile Height**
- **Small T-1 Size Diameter**  
3.18 mm (0.125 inch)
- **High Intensity**
- **IC Compatible**
- **Choice of 3 Bright Colors**  
High Efficiency Red  
Yellow  
High Performance Green

### Description

This family of diffused solid state lamps is especially suited for applications where small package size is required without sacrificing luminous intensity. The HLMP-1350 is a red tinted lamp providing a wide viewing angle. The HLMP-1450 and HLMP-1550 are similar products in yellow and green respectively.

### Package Dimensions

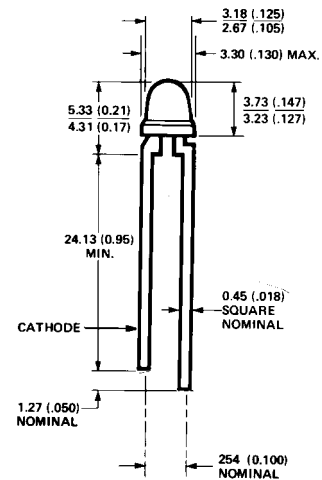

### Selection Guide

Part Number	Luminous Intensity $I_v$ (mcd)			Test Condition (mA)	Typical Viewing Angle <sup>[1]</sup> (Degrees), $2\theta^{1/2}$	Dominant Wavelength <sup>[2]</sup>
	Min.	Typ.	Max.			
HLMP-1350	1.3	2.3		10.0	55	626
HLMP-1350-C00xx	1.3	2.3		10.0	55	626
HLMP-1450	1.4	2.2		10.0	55	585
HLMP-1450-B00xx	1.4	2.2		10.0	55	585
HLMP-1550	1.0	3.1		20.0	55	569
HLMP-1550-A00xx	1.0	3.1		20.0	55	569
HLMP-1550-BC0xx	1.6	2.8	5.2	20.0	55	569

#### Notes:

1.  $\theta_{1/2}$  is the off-axis angle at which the luminous intensity is half the axial intensity.
2. The dominant wavelength,  $\lambda_d$ , is derived from the CIE chromaticity diagram and represents the single wavelength which defines the color of the device.

## Part Numbering System

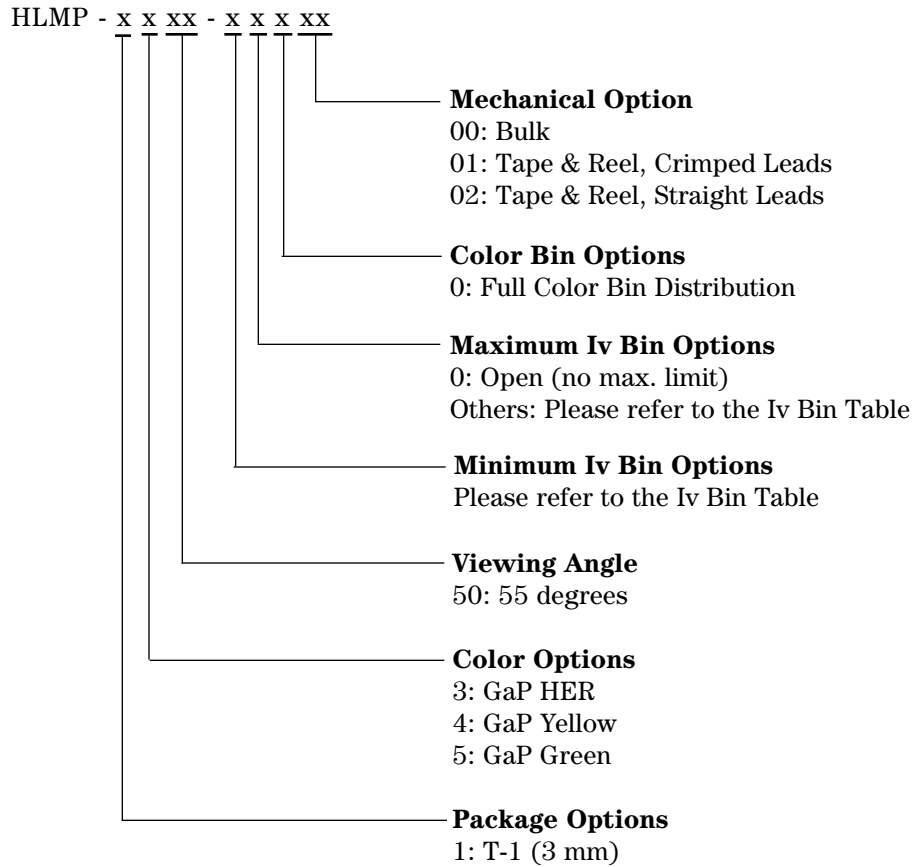

## Absolute Maximum Ratings

Parameter	HER	Yellow	Green	Units
Peak Forward Current	90	60	90	mA
Average Forward Current	25	20	25	mA
DC Current	30	20	30	mA
Reverse Voltage	5	5	5	V
Transient Forward Current (10 $\mu$ sec Pulse)	500	500	500	$\mu$ A
LED Junction Temperature	110	110	110	$^{\circ}$ C
Operating Temperature Range	-55 to +100	-55 to +100	-20 to +100	$^{\circ}$ C
Storage Temperature Range			-55 to +100	
Lead Soldering Temperature [1.6 mm (0.063 in.) from body]	260 $^{\circ}$ C for 5 Seconds			

### Notes:

- See Figure 5 (HER/Orange), 10 (Yellow), or 15 (Green/Emerald Green) to establish pulsed operating conditions.
- For Red, Orange, and Green series derate linearly from 50 $^{\circ}$ C at 0.5 mA/ $^{\circ}$ C. For Yellow series derate linearly from 50 $^{\circ}$ C at 0.2 mA/ $^{\circ}$ C.
- For Red, Orange, and Green series derate power linearly from 25 $^{\circ}$ C at 1.8 mW/ $^{\circ}$ C. For Yellow series derate power linearly from 50 $^{\circ}$ C at 1.6 mW/ $^{\circ}$ C.
- The transient peak current is the maximum nonrecurring peak current that can be applied to the device without damaging the LED die and wirebond. It is not recommended that the device be operated at peak currents beyond the peak forward current listed in the Absolute Maximum Ratings.

### Electrical Characteristics at $T_A = 25^\circ\text{C}$

Symbol	Description	Device HLMP	Min.	Typ.	Max.	Units	Test Conditions
$2\theta_{1/2}$	Included Angle Between Half Intensity Points	1350 1450 1550		55 55 55		Deg.	Note 1
$\lambda_{\text{peak}}$	Peak Wavelength	1350 1450 1550		635 583 565		nm	Note 2
$\lambda_d$	Dominant Wavelength	1350 1450 1550		626 585 569		nm	
$\Delta\lambda_{1/2}$	Spectral Line Halfwidth	1350 1450 1550		40 36 28		nm	
$\tau_s$	Speed of Response	1350 1450 1550		90 90 500		ns	
C	Capacitance	1350 1450 1550		11 15 18		pF	$V_F = 0$ $f = 1 \text{ MHz}$
$R\theta_{\text{J-PIN}}$	Thermal Resistance	1350 1450 1550		290		$^\circ\text{C/W}$	Junction to Cathode Lead
$V_F$	Forward Voltage	1350 1450 1550	1.6 1.6 1.6	1.9 2.0 2.1	3.0 3.0 3.0	V	$I_F = 10 \text{ mA}$
$V_R$	Reverse Breakdown Voltage	1350 1450 1550	5.0 5.0 5.0			V	$I_R = 100 \mu\text{A}$
$\eta_v$	Luminous Efficacy	1350 1450 1550		145 500 595		lumens/ Watt	Note 3

**Notes:**

- $\theta_{1/2}$  is the off-axis angle at which the luminous intensity is half the axial luminous intensity.
- The dominant wavelength,  $\lambda_d$ , is derived from the CIE chromaticity diagram and represents the single wavelength which defines the color of the device.
- Radiant intensity,  $I_e$ , in watts/steradian, may be found from the equation  $I_e = I_v/\eta_v$ , where  $I_v$  is the luminous intensity in candelas and  $\eta_v$  is the luminous efficacy in lumens/watt.

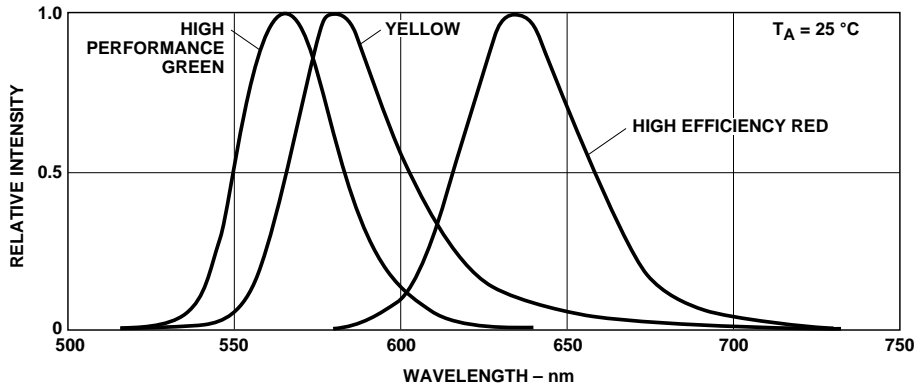

Figure 1. Relative Intensity vs. Wavelength.

### High Efficiency Red HLMP-1350

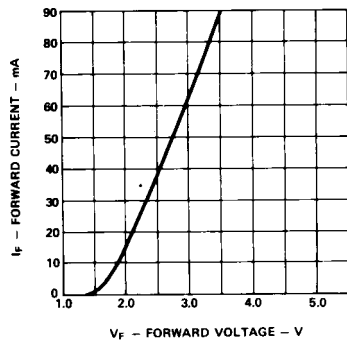

Figure 2. Forward Current vs. Forward Voltage Characteristics.

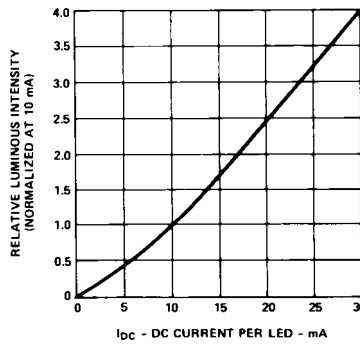

Figure 3. Relative Luminous Intensity vs. DC Forward Current.

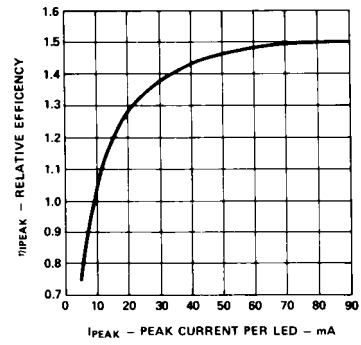

Figure 4. Relative Efficiency (Luminous Intensity per Unit Current) vs. Peak LED Current.

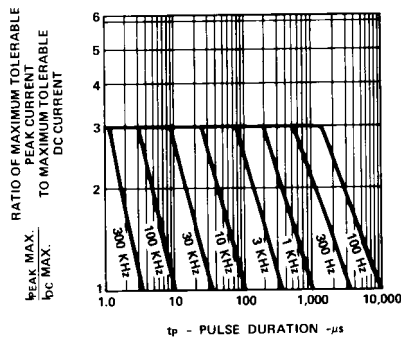

Figure 5. Maximum Tolerable Peak Current vs. Pulse Duration. ( $I_{DC}$  MAX as per MAX Ratings)

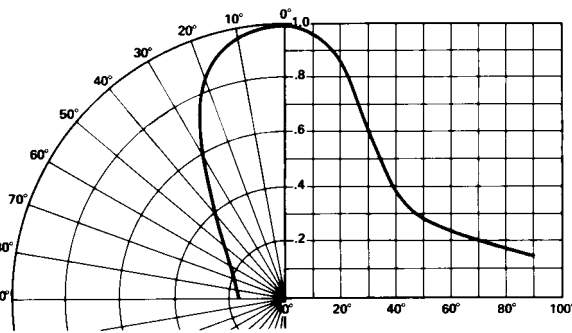

Figure 6. Relative Luminous Intensity vs. Angular Displacement.

## Yellow HLMP-1450

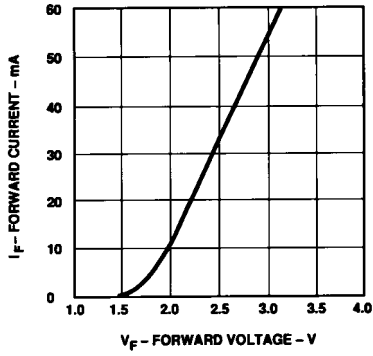

Figure 7. Forward Current vs. Forward Voltage Characteristics.

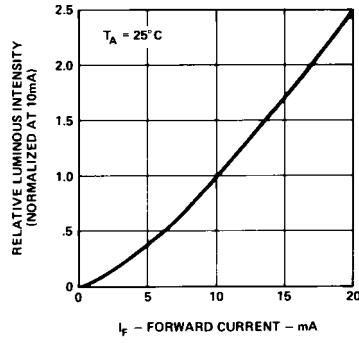

Figure 8. Relative Luminous Intensity vs. DC Forward Current.

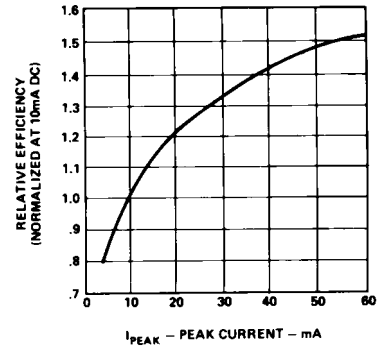

Figure 9. Relative Efficiency (Luminous Intensity per Unit Current) vs. Peak Current.

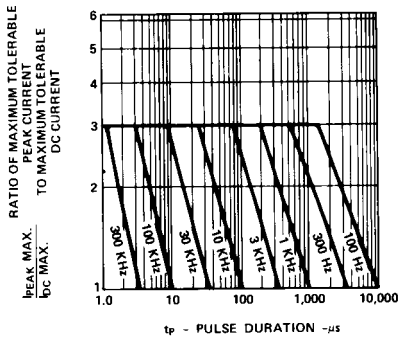

Figure 10. Maximum Tolerable Peak Current vs. Pulse Duration. ( $I_{DC}$  MAX as per MAX Ratings)

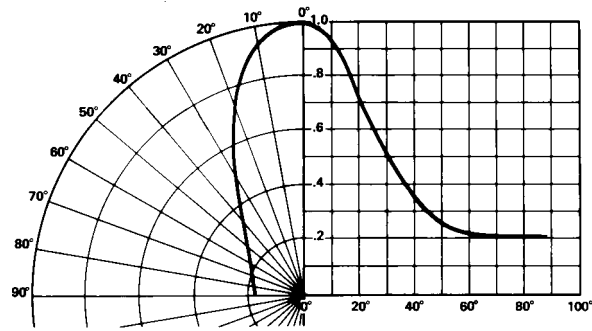

Figure 11. Relative Luminous Intensity vs. Angular Displacement.

## Green HLMP-1550

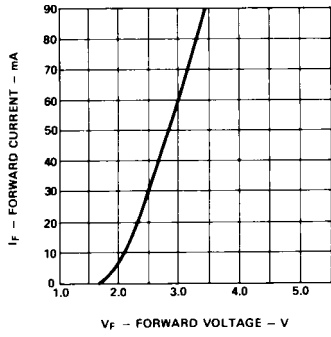

Figure 12. Forward Current vs. Forward Voltage Characteristics.

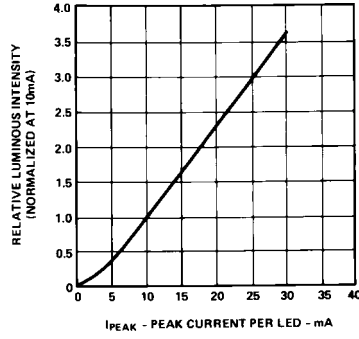

Figure 13. Relative Luminous Intensity vs. Forward Current.

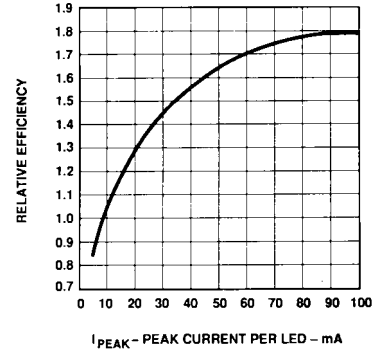

Figure 14. Relative Efficiency (Luminous Intensity per Unit Current) vs. Peak LED Current.

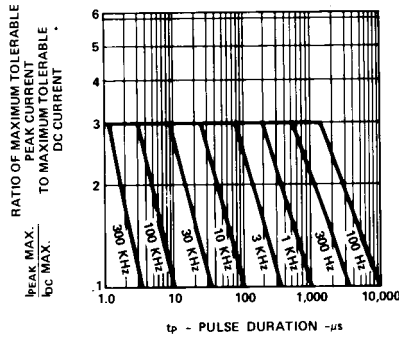

Figure 15. Maximum Tolerable Peak Current vs. Pulse Duration. ( $I_{DC}$  MAX as per MAX Ratings)

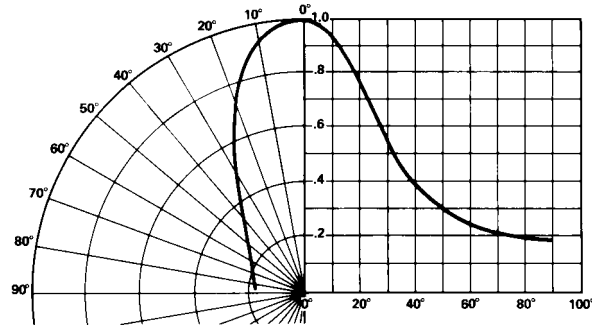

Figure 16. Relative Luminous Intensity vs. Angular Displacement.

### Intensity Bin Limits

Color	Bin	Intensity Range (mcd)	
		Min.	Max.
Red	C	1.5	2.4
	D	2.4	3.8
	E	3.8	6.1
	F	6.1	9.7
	G	9.7	15.5
	H	15.5	24.8
	I	24.8	39.6
	J	39.6	63.4
	K	63.4	101.5
	L	101.5	162.4
	M	162.4	234.6
	N	234.6	340.0
	O	340.0	540.0
	P	540.0	850.0
	Q	850.0	1200.0
	R	1200.0	1700.0
	S	1700.0	2400.0
	T	2400.0	3400.0
	U	3400.0	4900.0
	V	4900.0	7100.0
W	7100.0	10200.0	
X	10200.0	14800.0	
Y	14800.0	21400.0	
Z	21400.0	30900.0	

Maximum tolerance for each bin limit is  $\pm 18\%$ .

**Intensity Bin Limits, continued**

<b>Color</b>	<b>Bin</b>	<b>Intensity Range (mcd)</b>	
		<b>Min.</b>	<b>Max.</b>
Yellow	B	1.6	2.5
	C	2.5	4.0
	D	4.0	6.5
	E	6.5	10.3
	F	10.3	16.6
	G	16.6	26.5
	H	26.5	42.3
	I	42.3	67.7
	J	67.7	108.2
	K	108.2	173.2
	L	173.2	250.0
	M	250.0	360.0
	N	360.0	510.0
	O	510.0	800.0
	P	800.0	1250.0
	Q	1250.0	1800.0
	R	1800.0	2900.0
	S	2900.0	4700.0
T	4700.0	7200.0	
U	7200.0	11700.0	
V	11700.0	18000.0	
W	18000.0	27000.0	

Maximum tolerance for each bin limit is  $\pm 18\%$ .



**Intensity Bin Limits, continued**

Color	Bin	Intensity Range (mcd)	
		Min.	Max.
Green	A	1.1	1.8
	B	1.8	2.9
	C	2.9	4.7
	D	4.7	7.6
	E	7.6	12.0
	F	12.0	19.1
	G	19.1	30.7
	H	30.7	49.1
	I	49.1	78.5
	J	78.5	125.7
	K	125.7	201.1
	L	201.1	289.0
	M	289.0	417.0
	N	417.0	680.0
	O	680.0	1100.0
	P	1100.0	1800.0
	Q	1800.0	2700.0
	R	2700.0	4300.0
	S	4300.0	6800.0
T	6800.0	10800.0	
U	10800.0	16000.0	
V	16000.0	25000.0	
W	25000.0	40000.0	

Maximum tolerance for each bin limit is  $\pm 18\%$ .

## Color Categories

Color	Category #	Lambda (nm)	
		Min.	Max.
Green	6	561.5	564.5
	5	564.5	567.5
	4	567.5	570.5
	3	570.5	573.5
	2	573.5	576.5
Yellow	1	582.0	584.5
	3	584.5	587.0
	2	587.0	589.5
	4	589.5	592.0
	5	592.0	593.0
Orange	1	597.0	599.5
	2	599.5	602.0
	3	602.0	604.5
	4	604.5	607.5
	5	607.5	610.5
	6	610.5	613.5
	7	613.5	616.5
	8	616.5	619.5

Tolerance for each bin limit is  $\pm 0.5$  nm.

## Mechanical Option Matrix

Mechanical Option Code	Definition
00	Bulk Packaging, minimum increment 500 pcs/bag
01	Tape & Reel, crimped leads, minimum increment 1300 pcs/bag
02	Tape & Reel, straight leads, minimum increment 1300 pcs/bag

