

V_{DSM}	=	2800 V
I_{TAVM}	=	5490 A
I_{TRMS}	=	8625 A
I_{TSM}	=	75000 A
V_{T0}	=	0.86 V
r_T	=	0.070 mW

Phase Control Thyristor

5STP 45Q2800

Doc. No. 5SYA1050-01 Sep.00

- Patented free-floating silicon technology
- Low on-state and switching losses
- Designed for traction, energy and industrial applications
- Optimum power handling capability
- Interdigitated amplifying gate.

Blocking

Part Number	5STP 45Q2800	5STP 45Q2600	5STP 45Q2200	Conditions
V_{DRM} V_{RRM}	2800 V	2600 V	2200 V	$f = 50$ Hz, $t_p = 10$ ms
V_{RSM1}	3000 V	2800 V	2400 V	$t_p = 5$ ms, single pulse
I_{DRM}	≤ 400 mA			$T_j = 125^\circ\text{C}$
I_{RRM}	≤ 400 mA			
dV/dt_{crit}	1000 V/ μ s @ Exp. to $0.67 \times V_{DRM}$			

Mechanical data

F_M	Mounting force	nom.	90 kN
		min.	81 kN
		max.	108 kN
a	Acceleration	Device unclamped	50 m/s ²
		Device clamped	100 m/s ²
m	Weight		2.1 kg
D_S	Surface creepage distance		36 mm
D_a	Air strike distance		15 mm



ABB Semiconductors AG reserves the right to change specifications without notice.

ABB

On-state

I_{TAVM}	Max. average on-state current	5490 A	Half sine wave, $T_C = 70^\circ\text{C}$	
I_{TRMS}	Max. RMS on-state current	8625 A		
I_{TSM}	Max. peak non-repetitive surge current	75000 A	$t_p = 10 \text{ ms}$	$T_j = 125^\circ\text{C}$ After surge: $V_D = V_R = 0\text{V}$
		79000 A	$t_p = 8.3 \text{ ms}$	
I^2t	Limiting load integral	28125 kA^2s	$t_p = 10 \text{ ms}$	
		25900 kA^2s	$t_p = 8.3 \text{ ms}$	
V_T	On-state voltage	1.29 V	$I_T = 6000 \text{ A}$	$T_j = 125^\circ\text{C}$
V_{T0}	Threshold voltage	0.86 V	$I_T = 3000 - 9000 \text{ A}$	
r_T	Slope resistance	0.070 $\text{m}\Omega$		
I_H	Holding current	40-100 mA	$T_j = 25^\circ\text{C}$	
		20-75 mA	$T_j = 125^\circ\text{C}$	
I_L	Latching current	100-500 mA	$T_j = 25^\circ\text{C}$	
		150-350 mA	$T_j = 125^\circ\text{C}$	

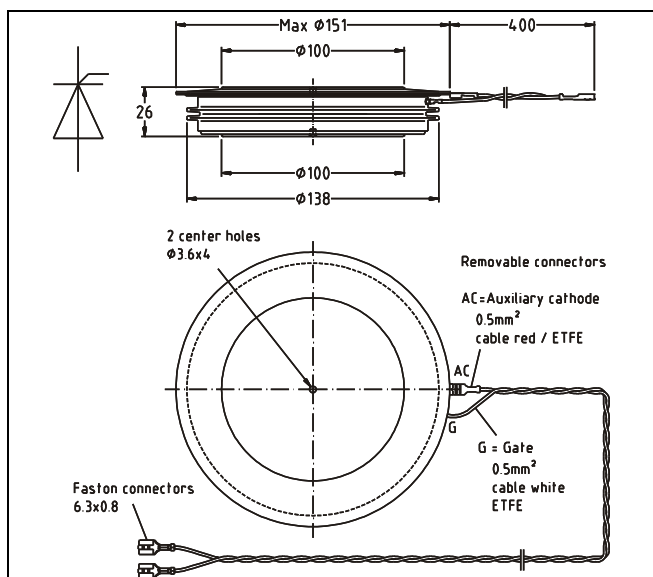
Switching

di/dt_{crit}	Critical rate of rise of on-state current	250 $\text{A}/\mu\text{s}$	Cont.	$V_D \leq 0.67 \cdot V_{DRM}$ $T_j = 125^\circ\text{C}$ $I_{TRM} = 3000 \text{ A}$ $f = 50 \text{ Hz}$ $I_{FG} = 2.0 \text{ A}$ $t_r = 0.5 \mu\text{s}$
		500 $\text{A}/\mu\text{s}$	60 sec.	
t_d	Delay time	$\leq 3.0 \mu\text{s}$	$V_D = 0.4 \cdot V_{DRM}$	$I_{FG} = 2.0 \text{ A}$ $t_r = 0.5 \mu\text{s}$
t_q	Turn-off time	$\leq 400 \mu\text{s}$	$V_D \leq 0.67 \cdot V_{DRM}$ $dv_D/dt = 20\text{V}/\mu\text{s}$	$I_{TRM} = 3000 \text{ A}$ $T_j = 125^\circ\text{C}$ $V_R > 200 \text{ V}$
Q_{rr}	Recovery charge	min	4200 μAs	$di_T/dt = -5 \text{ A}/\mu\text{s}$
		max	6500 μAs	

Triggering

V_{GT}	Gate trigger voltage	2.6 V	$T_j = 25^\circ\text{C}$
I_{GT}	Gate trigger current	400 mA	$T_j = 25^\circ\text{C}$
V_{GD}	Gate non-trigger voltage	0.3 V	$V_D = 0.4 \cdot V_{DRM}$
I_{GD}	Gate non-trigger current	10 mA	$V_D = 0.4 \cdot V_{DRM}$
V_{FGM}	Peak forward gate voltage	12 V	
I_{FGM}	Peak forward gate current	10 A	
V_{RGM}	Peak reverse gate voltage	10 V	
P_G	Maximum gate power loss	3 W	

Thermal

$T_{j\ max}$	Max. junction temperature	125°C	
$T_{j\ stg}$	Storage temperature range	-40...150°C	
R_{thJC}	Thermal resistance junction to case	10 K/kW	Anode side cooled
		10 K/kW	Cathode side cooled
		5 K/kW	Double side cooled
R_{thCH}	Thermal resistance case to heat sink	2 K/kW	Single side cooled
		1 K/kW	Double side cooled

Analytical function for transient thermal impedance:

$$Z_{thJC}(t) = \sum_{i=1}^n R_i(1 - e^{-t/t_i})$$

i	1	2	3	4
R_i (K/kW)	3.27	0.736	0.661	0.312
τ_i (s)	0.5237	0.1082	0.02	0.0075

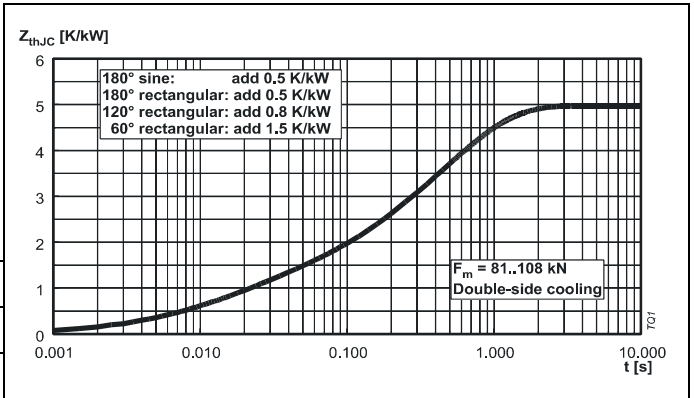

Fig. 1 Transient thermal impedance junction to case.

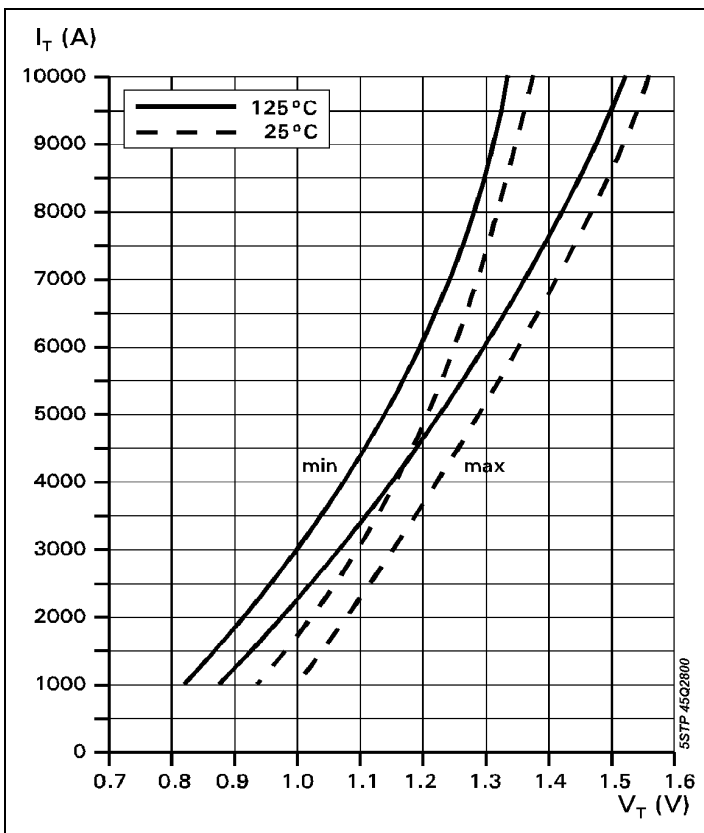

Fig. 2. On-state characteristics.

On-state characteristic model:

$$V_T = A + B \cdot i_T + C \cdot \ln(i_T + 1) + D \cdot \sqrt{i_T}$$

Valid for $i_T = 500 - 15000$ A

A	B	C	D
-0.096289	0.000051	0.135731	-0.001358

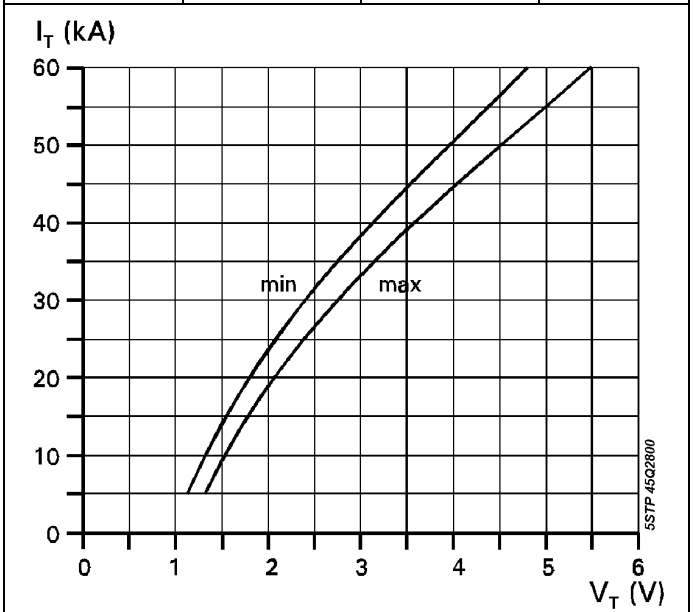

Fig. 3 On state characteristics.

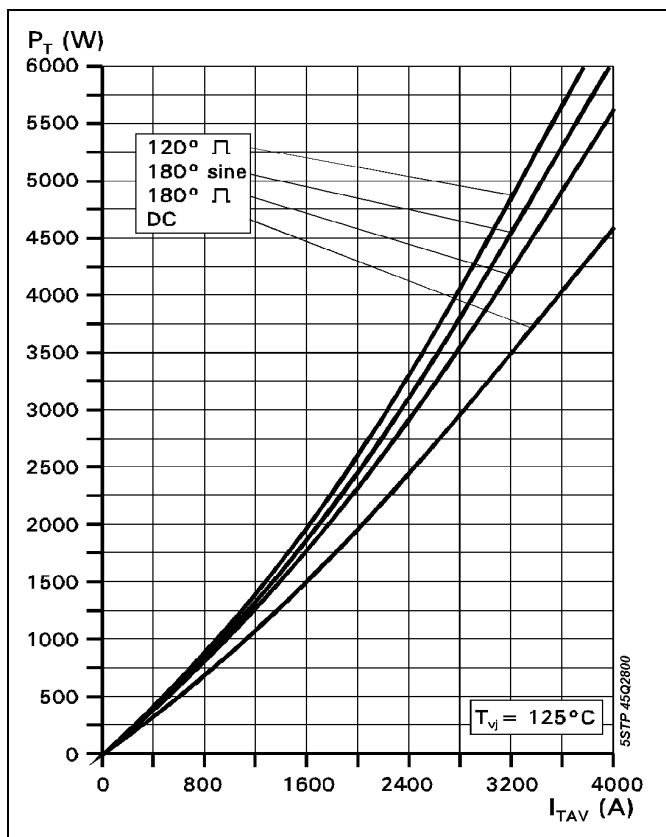

Fig. 4 On-state power dissipation vs. mean on-state current. Turn-on losses excluded.

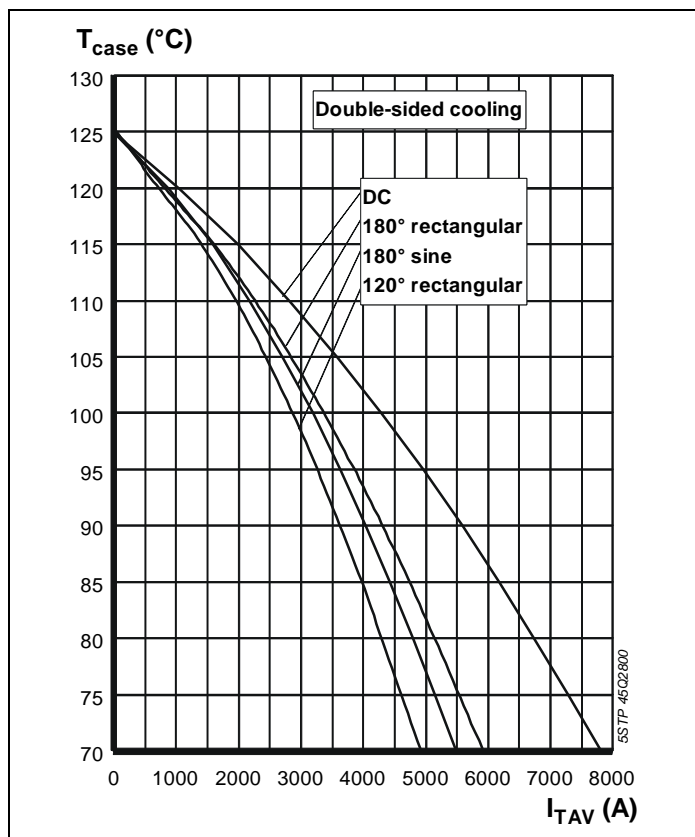

Fig. 5 Max. permissible case temperature vs. mean on-state current.

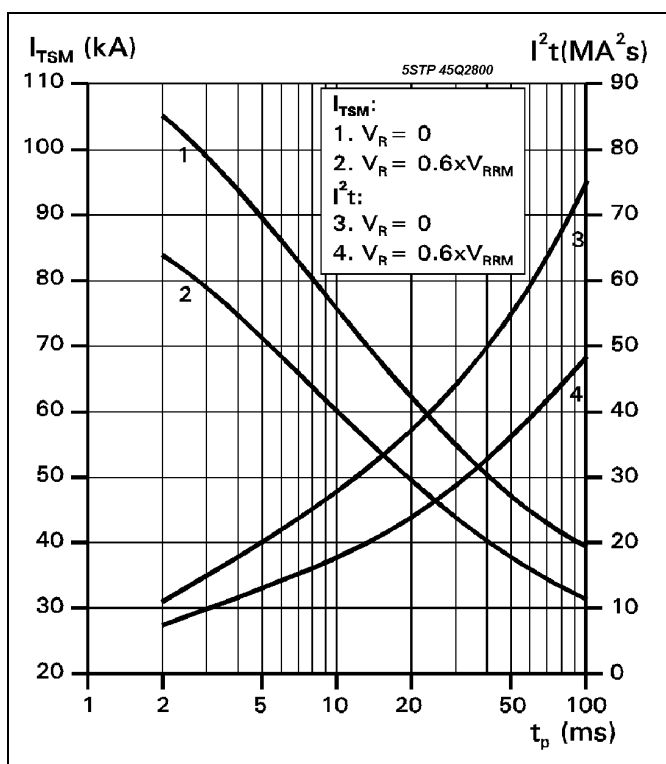

Fig. 6 Surge on-state current vs. pulse length. Half-sine wave.

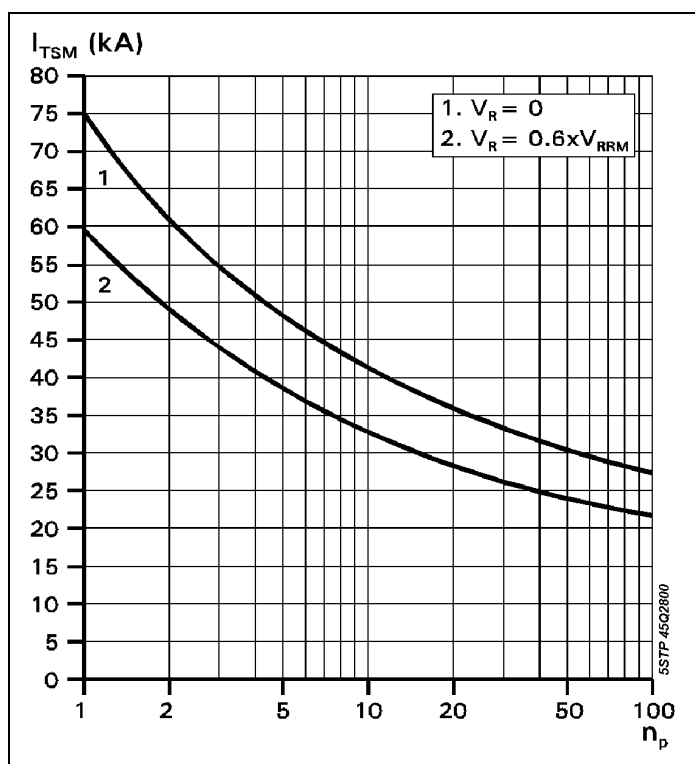

Fig. 7 Surge on-state current vs. number of pulses. Half-sine wave, 10 ms, 50Hz.

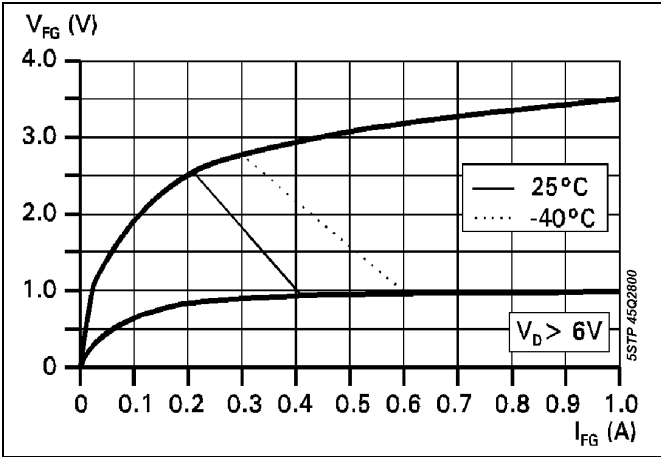

Fig. 8 Gate trigger characteristics.

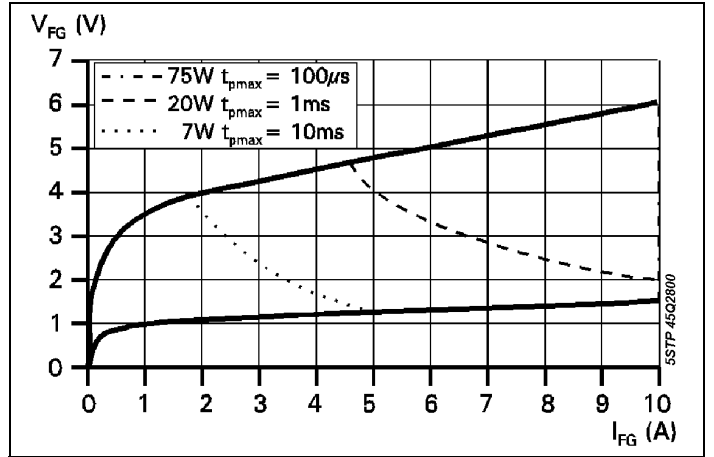

Fig. 9 Max. peak gate power loss.

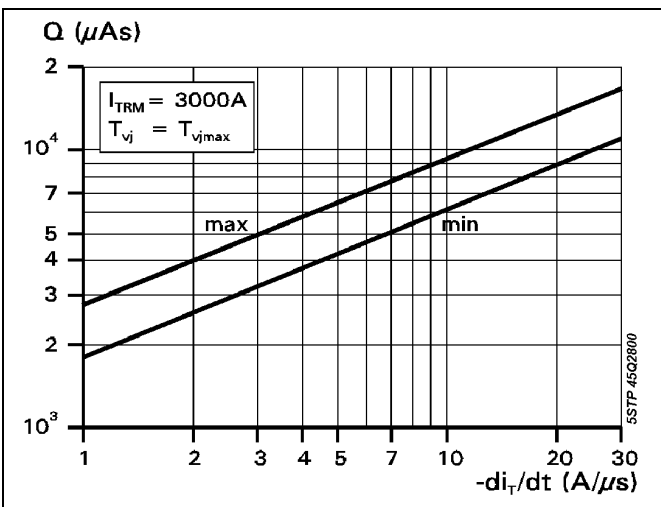

Fig. 10 Recovery charge vs. decay rate of on-state current.

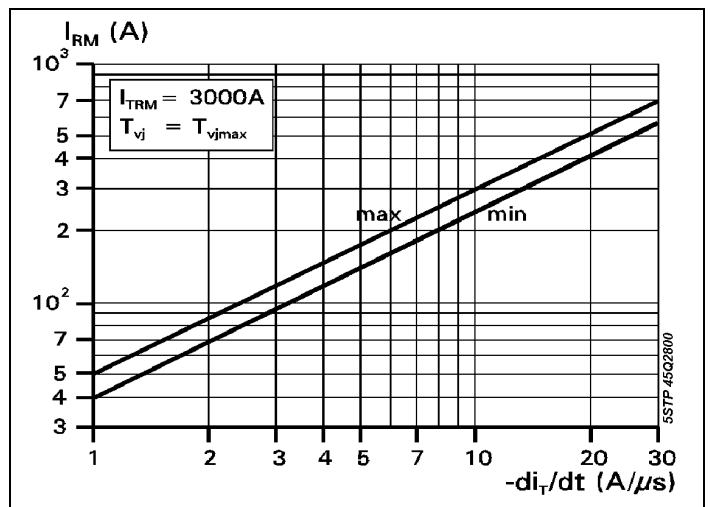

Fig. 11 Peak reverse recovery current vs. decay rate of on-state current.

Turn –off time, typical parameter relationship.

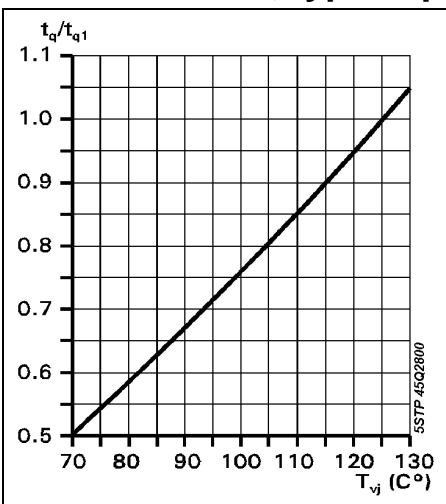

Fig. 12 $t_q/t_{q1} = f_1(T_j)$

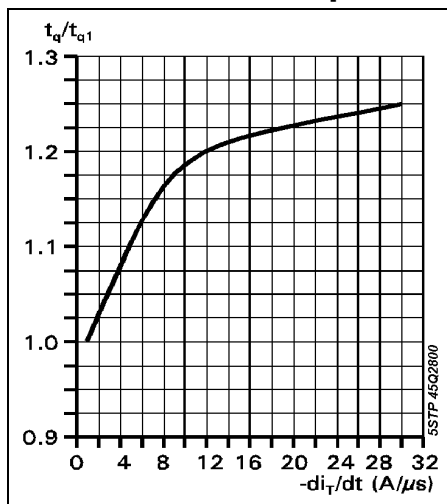

Fig. 13 $t_q/t_{q1} = f_2(-di/dt)$

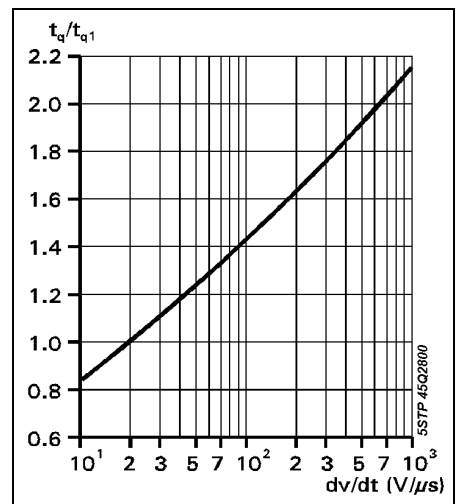

Fig. 14 $t_q/t_{q1} = f_3(dv/dt)$

$t_q = t_{q1} \cdot t_q/t_{q1} f_1(T_j) \cdot t_q/t_{q1} f_2(-di/dt) \cdot t_q/t_{q1} f_3(dv/dt)$ t_{q1} : at normalized values (see page 2)
 t_q : at varying conditions

Turn-on and Turn-off losses

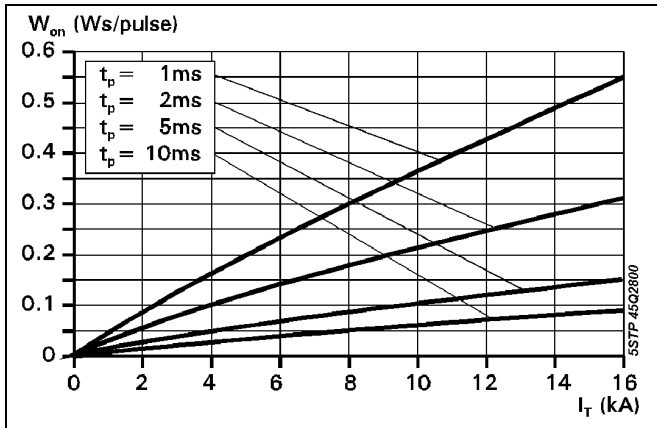

Fig. 15 $W_{on} = f(I_T, t_p)$, $T_j = 125^\circ\text{C}$.
Half sinusoidal waves.

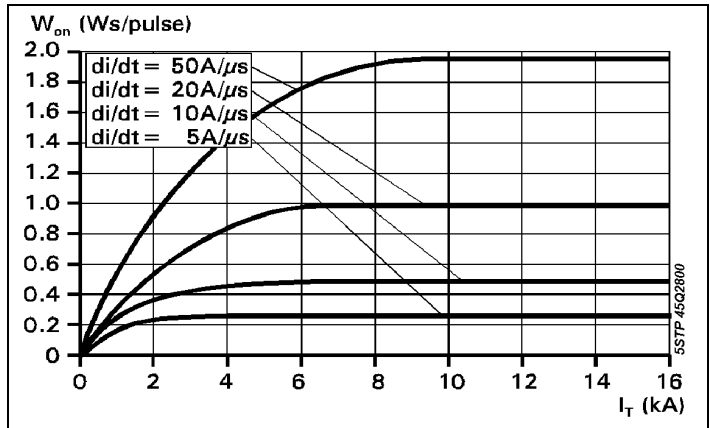

Fig. 16 $W_{on} = f(I_T, di/dt)$, $T_j = 125^\circ\text{C}$.
Rectangular waves.

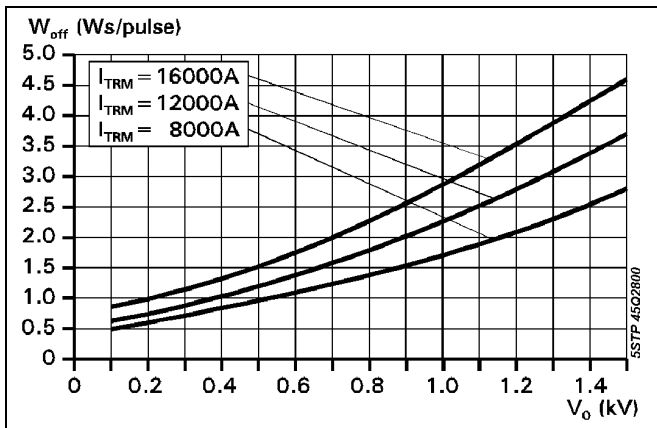

Fig. 17 $W_{off} = f(V_o, I_T)$, $T_j = 125^\circ\text{C}$.
Half sinusoidal waves. $t_p = 10\text{ms}$.

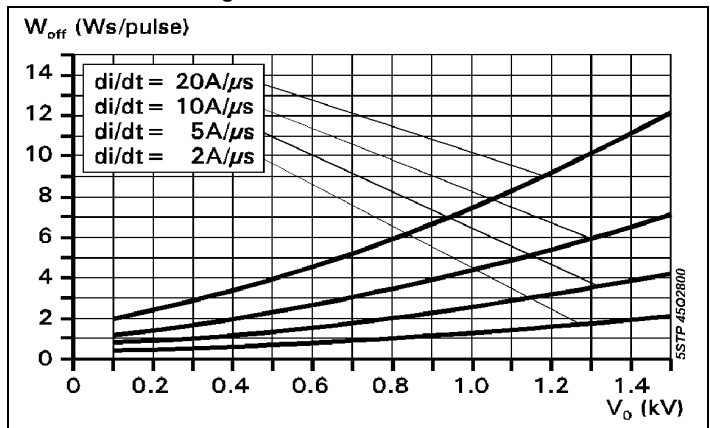

Fig. 18 $W_{off} = f(V_o, di/dt)$, $T_j = 125^\circ\text{C}$.
Rectangular waves.

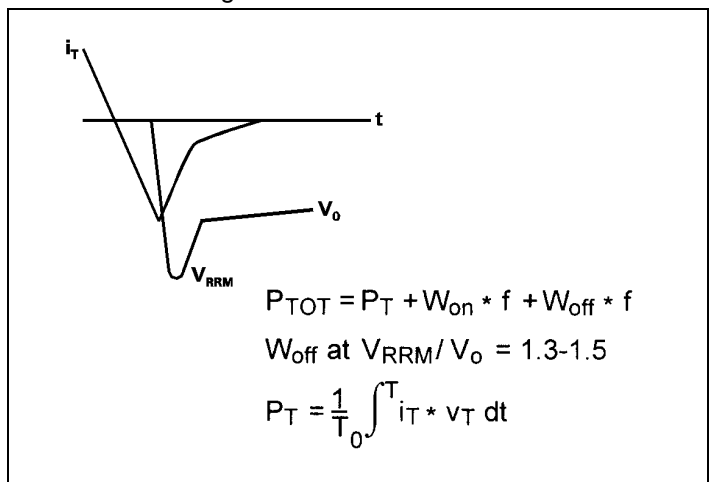

ABB Semiconductors reserves the right to change specifications without notice.



ABB Semiconductors AG
Fabrikstrasse 3
CH-5600 Lenzburg, Switzerland

Telephone +41 (0)62 888 6419
Fax +41 (0)62 888 6306
Email Info@ch.abb.com
Internet www.abbsem.com